

S8740-1

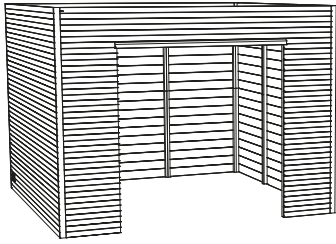

S8741-1

BARI

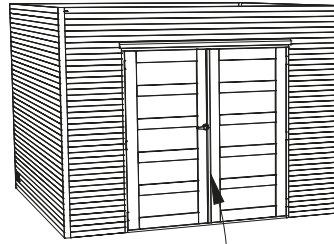

S8054C-1

S8742-1

TARENTO

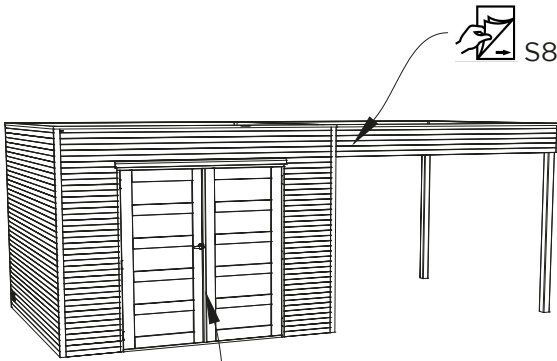

S8751-1



S8054C-1

S8743-1

MATERA

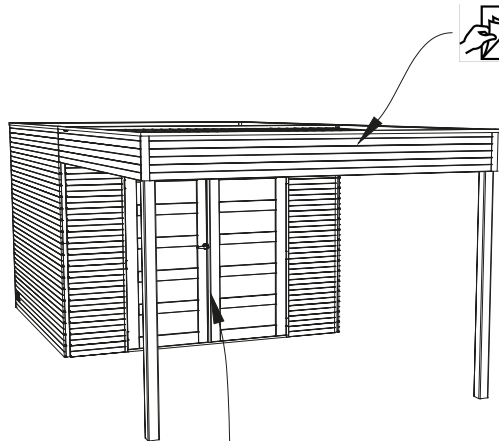

S8752-1



S8054C-1



S8740-1

(NL) VOOR AANVANG VAN DE MONTAGE :

Bij ontvangst van het pakket dient u de geleverde stukken en hun aantallen te controleren aan de hand van de stuklijst (lijst 'SAV') om u ervan te vergewissen dat u alle stukken ontvangen hebt en dat die zich in goede staat bevinden. Het is sterk aan te raden niet met de montage te beginnen voor u deze controle hebt uitgevoerd en indien nodig de vervangstukken ontvangen hebt. Het is tevens verplicht het artikel op een betonplaat te monteren. Het is heel belangrijk te controleren dat alles waterpas gemonteerd werd en onder de correcte rechte hoek. Heel belangrijk is dat u het natuurlijke krimpen en uitzetten van het hout toelaat en de structuur niet blokkeert. (pas op met kasten, rekken, hangplanken, rails,...)

U heeft een geïmpregneerd artikel aangekocht en dit heeft enkele consequenties wat de montage betreft.

Door de opname van het beschermend product zullen alle onderdelen licht afwijkende afmetingen hebben en wij raden ten stilligste aan alles open te leggen om een zo goed mogelijke droging te bekommen alvorens de montage aan te vangen.

Verder is het niet abnormaal dat kleine openingen te zien zijn bij de montage, zowel boven de deur als bij de dakopbouw. Deze zullen na het natuurlijk drogen van het product verdwijnen, hou er evenwel rekening mee dat dit enkele weken kan duren.

(FR) AVANT LE MONTAGE :

A réception du colis, il convient de vérifier, par rapport à la nomenclature de l'abri (feuille SAV) que toutes les pièces figurent bien dans le colis et sont en bon état. Il est judicieux de ne commencer le montage effectif de l'abri qu'après avoir effectué cette vérification et éventuellement avoir reçu les pièces nécessaires au remplacement des pièces défectueuses. Il est impératif de monter l'article sur une dalle de béton. Il est très important de s'assurer de l'horizontalité de l'abri ainsi que de l'équerrage. Par ailleurs, il est impératif de ne pas fixer entre elles les planches constituant la structure de l'abri. (attention aux équerres, étagères, rails,...)

Vous avez acheté un article imprégné et cela a bien quelques conséquences en ce qui concerne le montage.

Par l'absorption du produit protégeant toutes les parties auront des mesures légèrement divergentes.

On conseille dès lors fortement d'exposer à l'air extérieur toutes les parties en visant un meilleur séchage avant de commencer le montage.

Puis il n'est pas anormal qu'il y ait des petits trous à voir lors du montage tant au-dessus de la porte qu'en montant le toit.

Ceux-ci disparaîtront après le séchage naturel du produit. Tenez cependant compte que cela peut durer quelques semaines.

(GB) BEFORE THE ASSEMBLY :

When you receive the pack, please check if all the supplied pieces and their numbers comply with the parts list "SAV" to make sure you have received all the pieces and that they are in good condition. It is strongly recommended not to start the installation before completing this check and if necessary, receiving the replacement parts. Furthermore, it is mandatory to install the product on a concrete slab, with a foil against rising damp underneath. The product must be installed level, fitted with the required drainage channels and at the correct right angle. It is very important that you allow the natural expansion and contraction of the wood and that you do not block the structure (watch out with cupboards, racks, hanging shelves, rails, etc.).

You have purchased an impregnated article, which has some implications regarding the assembly. Due to the absorption of the protective product, all parts will have slightly different dimensions and we strongly recommend to lay everything open in order let the parts dry as well as possible before starting the assembly.

Furthermore, it is not unusual that small openings are visible during the assembly, both above the door and in the roof. These will disappear after the natural drying of the product, keep in mind, however, that this may take several weeks.

(D) VOR ANFANG DES AUFBAUS :

Beim Erhalt des Pakets sind die gelieferten Teile sowie ihre Mengen anhand der Stückliste (Liste „SAV“) zu überprüfen, damit Sie sich davon überzeugen können, dass Sie sämtliche Teile erhalten haben, und dass diese einwandfrei sind. Es ist durchaus empfehlenswert, nicht mit dem Aufbau anzufangen ehe Sie dies überprüft und erforderlichenfalls die Ersatzteile erhalten haben. Es ist zudem fepflicht, den Artikel auf einer Betonplatte aufzustellen. Es ist aber sehr wichtig, zu überprüfen, dass die Gesamtheit waagrecht und im richtigen geraden Winkel aufgebaut wurde. Sehr wichtig ist, dass Sie das natürliche Schwinden und Quellen des Holzes erlauben und das Gefüge nicht sperren. (Bitte achten Sie auf Schränke, Regale, Hängebretter, Schienen, usw.)

Sie haben einen imprägnierten Artikel erworben, und dies hat einige Auswirkungen auf den Aufbau.

Wegen der Aufnahme des schützenden Produktes werden sämtliche Teile etwas abweichende Abmessungen aufweisen. Wir empfehlen daher unbedingt, das Ganze auszulegen, damit Sie eine möglichst gute Trocknung erreichen, ehe Sie mit dem Aufbau anfangen.

Weiterhin ist es nicht abnormal, dass beim Aufbau, sowohl oberhalb der Tür als auch beim Dachaufbau kleine Öffnungen zu sehen sind. Nach der natürlichen Trocknung des Produktes werden diese verschwinden. Berücksichtigen Sie aber, dass dies einige Wochen in Anspruch nehmen kann.

(ES) ANTES DEL MONTAJE :

Nada más recibir el paquete usted tiene que controlar las piezas entregadas y el número de ellas a través de la lista (lista 'SAV') para que pueda averiguar si ha recibido todas las piezas y si ellas se encuentran en buen estado. Es muy aconsejable que usted no empiece con el montaje antes de haber hecho este control y, si fuera necesario, antes de haber recibido las piezas de repuesto. Además se recomienda montar el artículo en la chapa de hormigón. Pero de todos modos es muy importante que usted averigüe que todo fue montado a nivel y bajo el ángulo recto adecuado. Es muy importante que usted admita el encogimiento y la expansión naturales de la madera y que no se bloquee la estructura (cuidado con armarios, anaqueles, estantes, railes, etc.).

Usted compró un artículo impregnado, lo que lleva a unas consecuencias en cuanto al montaje.

Por la absorción del producto protector, todas las piezas tendrán unas dimensiones ligeramente divergentes. Nos le aconsejamos vivamente abrir todo para que todo se seque lo antes posible, antes de empezar con el montaje.

Además, no es nada abnormal que se ve pequeños huecos con el montaje, tanto arriba de la puerta como con la construcción del techo. Esos huecos desaparecerán después de haber secado de modo natural. Sin embargo, hay que darse cuenta de que ese proceso puede durar unas semanas.

(P) ANTES DE PROCEDER À MONTAGEM :

Logo que tenha recebido a encomenda, convém que verifique, em relação à lista das peças (a lista 'SAV'), se recebeu todas as peças e se elas se encontram em bom estado. É aconselhável não começar com a montagem antes de ter efetuado esta verificação e de eventualmente ter recebido as peças necessárias para substituir as peças defeituosas. Recomenda-se também que monte o artigo numa placa de betão. Pode sempre optar por montar o produto num suporte diferente, mas é em todo o caso importante verificar a horizontalidade e a ortogonalidade do produto. É também indispensável que permita o encolhimento e dilatação naturais da madeira e que não bloquee a estrutura. (Cuidado com armários, estantes, prateleiras, calhas,...)

Acaba de comprar um produto impregnado e isto tem algumas consequências no que diz respeito à montagem.

Devido à absorção do produto de proteção todas as partes terão medidas ligeiramente divergentes.

Recomendamos fortemente que exponha todas as peças ao ar exterior a fim de garantir uma boa secagem antes de proceder à montagem.

Além disso, não é anormal que haja pequenas gretas após a montagem, tanto em cima da porta como na montagem do telhado. Estas desaparecerão depois da secagem natural do produto. Porém, tenha em conta que isto poderá durar algumas semanas.

(I) PRIMA DEL MONTAGGIO :

Al ricevimento del pacco, il cliente deve controllare i componenti forniti e i loro numeri sulla base dell'elenco dei pezzi (elenco "SAV"), per essere certo di aver ricevuto tutti i componenti e che essi siano in buono stato. Si consiglia vivamente di non procedere al montaggio prima di aver eseguito tale controllo e, qualora necessario, aver ricevuto i pezzi di ricambio. Si consiglia altresì di montare l'articolo su una lastra di cemento. In ogni caso, è molto importante controllare che il tutto sia stato montato con l'orizzontalità e l'ortogonalità corretta. È altresì essenziale, ovviamente, consentire il restringimento e la dilatazione naturale del legno e non bloccare la struttura (prestare attenzione ad armadi, scaffali, mensole sospese, traverse).

Ha acquistato un articolo impregnato, il che ha conseguenze sul montaggio.

Tutti i componenti avranno misure leggermente diverse, a causa dell'assorbimento del prodotto protettivo. Raccomandiamo vivamente di esporre il tutto all'aria aperta per conseguire l'asciugatura migliore possibile prima di iniziare il montaggio.

Le piccole aperture che si notano durante il montaggio sia sopra alla porta, sia verso il tetto non rappresentano anomalie: spariranno dopo la naturale asciugatura del legno. Tenga, tuttavia, conto che possono volerci alcune settimane.

(CZ) PŘED ZAHÁJENÍM MONTÁŽE :

Při přijetí balíčku prosím zkontrolujte dodané díly a jejich množství podle kusovníku (seznam „SAV“) a ujistěte se, že jste obdrželi všechny díly a že jsou díly nepoškozené. Výrazně doporučujeme nezačínat s montáží dřeva, než provedete tuto kontrolu nebo než případně obdržíte náhradní kusy. Stejně tak výrazně doporučujeme montovat výrobek na betonovou desku. Můžete se také rozhodnout provést montáž na jiný podklad, ale i v tom případě je velmi důležité zkontrolovat, zda jsou všechny díly smontovány vodorovně a ve správném pravém úhlu. Neméně důležité je, abyste umožnili přirozené smršťování a roztahování dřeva a neblokovali jeho strukturu (opatrně se skříněmi, regály, závěsnými deskami, kolejnicemi,...)

Zakoupili jste impregnovaný výrobek a to má určité důsledky týkající se montáže.

V důsledku absorpcí ochranného produktu se budou rozměry všech dílů mírně lišit, a proto výrazně doporučujeme všechny díly po vybalení rozložit a zajistit k nim přístup vzduchu, čímž umožníte jejich vysušení ještě předtím, než zahájíte montáž. Dále je možné, že při montáži uvidíte malé otvory, a to jak nad dveřmi, tak u osazení střechy. Nejedná se o závadu. Otvory zmizí po přirozeném vyschnutí výrobku, to může nicméně trvat i několik týdnů.



S8740-1

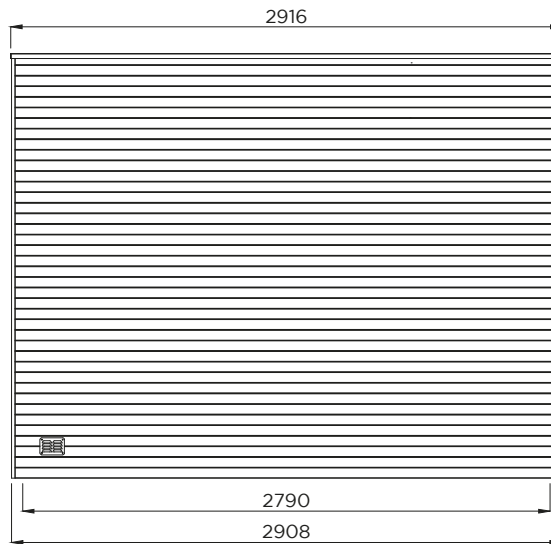
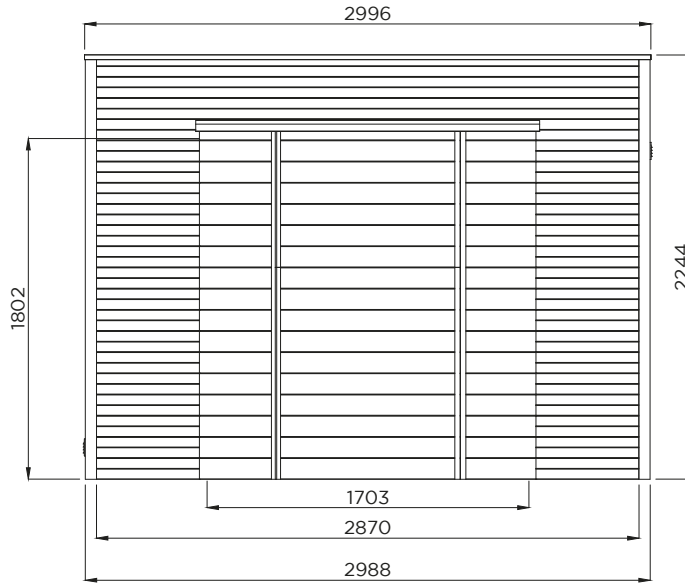

8.01m²



8.69m²



8.74m²



8.59m²

1°

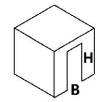

(B)
1703
(H)
1802

Industriepark 8
8587 Spiere-Helkijn

CreateDate: 23.03.2021
SaveDate: 23.03.2021
PlotDate: 25.03.2021

Deze technische tekening, montagehandleiding, afgeleide of detail ervan kan beschermd zijn door intellectuele eigendomsrechten en niets daarvan mag zonder schriftelijke toestemming van Solid NV worden gereproduceerd of gebruikt; anders dan het downloaden, het bekijken daarvan op een enkele computer en/of printen van een enkele hardcopy ten behoeve van persoonlijk, niet-bedrijfsmatig gebruik. Elk ander gebruik van deze informatie (inclusief, maar niet beperkt tot, het geheel of gedeeltelijk reproduceren, de verdere verspreiding of distributie ervan onder welke vorm dan ook) is verboden en kan strafrechtelijk vervolgd worden. Met dank voor uw medewerking.

EAN code: ----



S8740-1

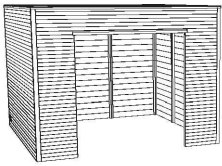

ASKAO

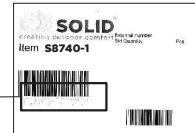

Ref.	Index	#
↓	↓	↓
A1	WP019x123-CDEV-TPP-1-0448x2870	1
A2	WP019x123-CDER-TPP-1-1120x2870	1
A3	WP019x123-CGAU-TPP-1-1120x2870	1
A4	WP019x123-CDRO-TPP-1-1120x2870	1
B1	WP019x123-CPPN-000-1-1131x2870	1
B2	WP019x123-CPPN-000-1-1131x2870	2
C	WP019x123-CPPU-000-1-2160x0545	2
D1	WW040x040-4FA-000-1-2066	2
D2	WW040x040-4FA-000-1-2056	2
D3	WW028x040-4FA-000-1-2132	2
J	WW016x095-PLA-000-1-2867	34
K	WW040x145-4FA-IF0-1-2950	2
L	WW019x059-4FA-000-1-2240	4
O	S5015 EPDM (3200x3200)	1

Afmetingen, uiterlijk, vorm, gewicht kunnen afwijken.
 Les dimensions, l'apparence, la forme, le poids peuvent différer.
 Dimensions, appearance, shape, weight may differ.
 Maße, Aussehen, Form, Gewicht können abweichen.

www.solid.eu/sav

Gereedschap (excl.) / Outils (excl.) / Tools (excl.) / Werkzeuge (exkl.)



Hamer
Marteau
Hammer



Schroefboormachine
Perceuse / Visseuse
Screw drill
Schraubenbohrer



Ladder
Echelle
Leiter



Winkelhaak
Crochet carré
Square hook
Quadratischer Haken



Cirkelzaag
Scie circulaire
Circular saw
Kreissäge



Klokboor Ø 60mm
Scie cloche Ø 60mm
Hole saw Ø 60mm
Bohren Ø 60mm



Handzaag
Scie à main
Saw



Meter
Mètre
Meter
Rollenmesser



Breekmas
Couteau
Cutter
Messer



Waterpas
Niveau à bulle
Plumb rule
Wasserwaage



Decoupeerzaag
Scie sauteuse
Jigsaw
Stichsäge













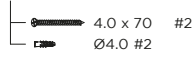



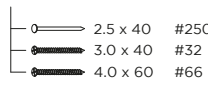

Silicone + pomp
Silicone + pompe
Silicone + pump
Silikon + Pumpe

S8740-1

Afmetingen, uiterlijk, vorm, gewicht kunnen afwijken.
 Les dimensions, l'apparence, la forme, le poids peuvent différer.
 Dimensions, appearance, shape, weight may differ.
 Maße, Aussehen, Form, Gewicht können abweichen.

www.solid.eu/sav

Ref.	Index	#
 O1	S5010 Contactspray	4
P	S8054-K-1	1
P	S8084ALU	1
 P	S618  4.0 x 70 #2 Ø4.0 #2	1
 P	S80201	1
 P	S6203-L	3
 P	S6203-R	3
 P	S673 (x2)	1
 R	S8740-Zmt  2.5 x 40 #250 3.0 x 40 #32 4.0 x 60 #66	1
 V1	S5018 Drainage pipe connection	1
 V2	S5232 Drainage pipe	1
 V3	S5238 Drainage pipe corner 45°	2
 V4	S5236 Fixo PVC	2
 Z	S6746 Ventilation-kit	1
 X1	S6707 25x25x3 CENTER (2996)	2
 X2	S6707 25x25x3 CENTER (2916)	2

Gereedschap (excl.) / Outils (excl.) / Tools (excl.) / Werkzeuge (exkl.)



Hamer
Marteau
Hammer
Hammer



Schroefboormachine
Perceuse / Visseuse
Screw drill
Schraubenbohrer



Ladder
Echelle
Ladder
Leiter



Winkelhaak
Crochet carré
Square hook
Quadratischer Haken



Cirkelzaag
Scie circulaire
Circular saw
Kreissäge



Klokboor Ø 60mm
Scie cloche Ø 60mm
Hole saw Ø 60mm
Bohren Ø 60mm



Handzaag
Scie à main
Saw
Säge



Meter
Mètre
Meter
Rollenmesser



Breekmas
Couteau
Cutter
Messer



Waterpas
Niveau à bulle
Plumb rule
Wasserwaage



Decoupeerzaag
Scie sauteuse
Jigsaw
Stichsäge



Silicone + pomp
Silicone + pompe
Silicone + pump
Silikon + Pumpe

NL

Bij de montageschappen waar onderstaand pictogram staat is het aangewezen om silicone aan te brengen.

F

Il est recommandé d'appliquer du silicone pendant les étapes de montage où l'icône ci-dessous est affichée.

GB

It is recommended to apply silicone during the assembly steps where the icon below is shown.

D

Es wird empfohlen, während der Montageschritte Silikon aufzutragen, wenn das Symbol unten angezeigt wird.

!! Silicone aanbrengen (excl.)
!! Appliquer du silicone (excl.)
!! Apply silicone (excl.)
!! Silikon auftragen (excl.)

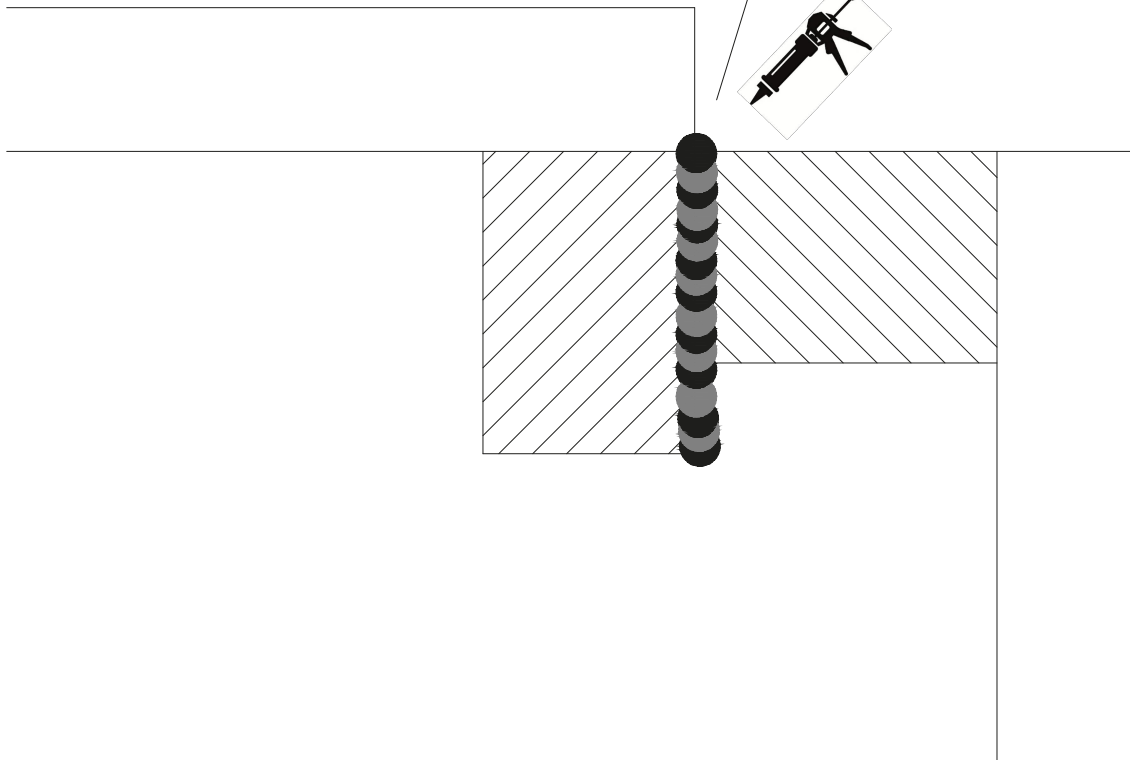

S8740-1

B1 = 1
B2 = 1
 4.0 x 60 # 4

1

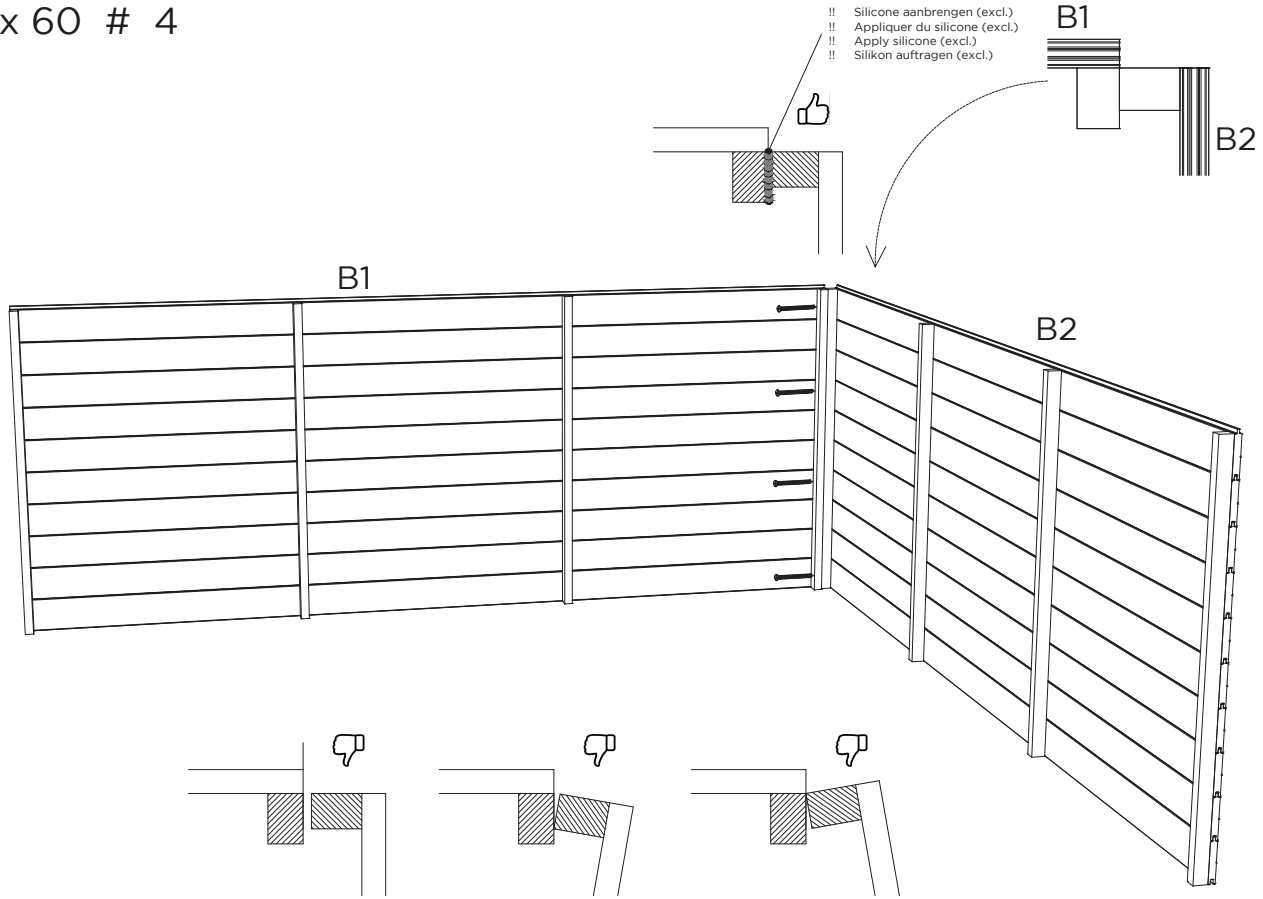

B2 = 1
 4.0 x 60 # 4

2

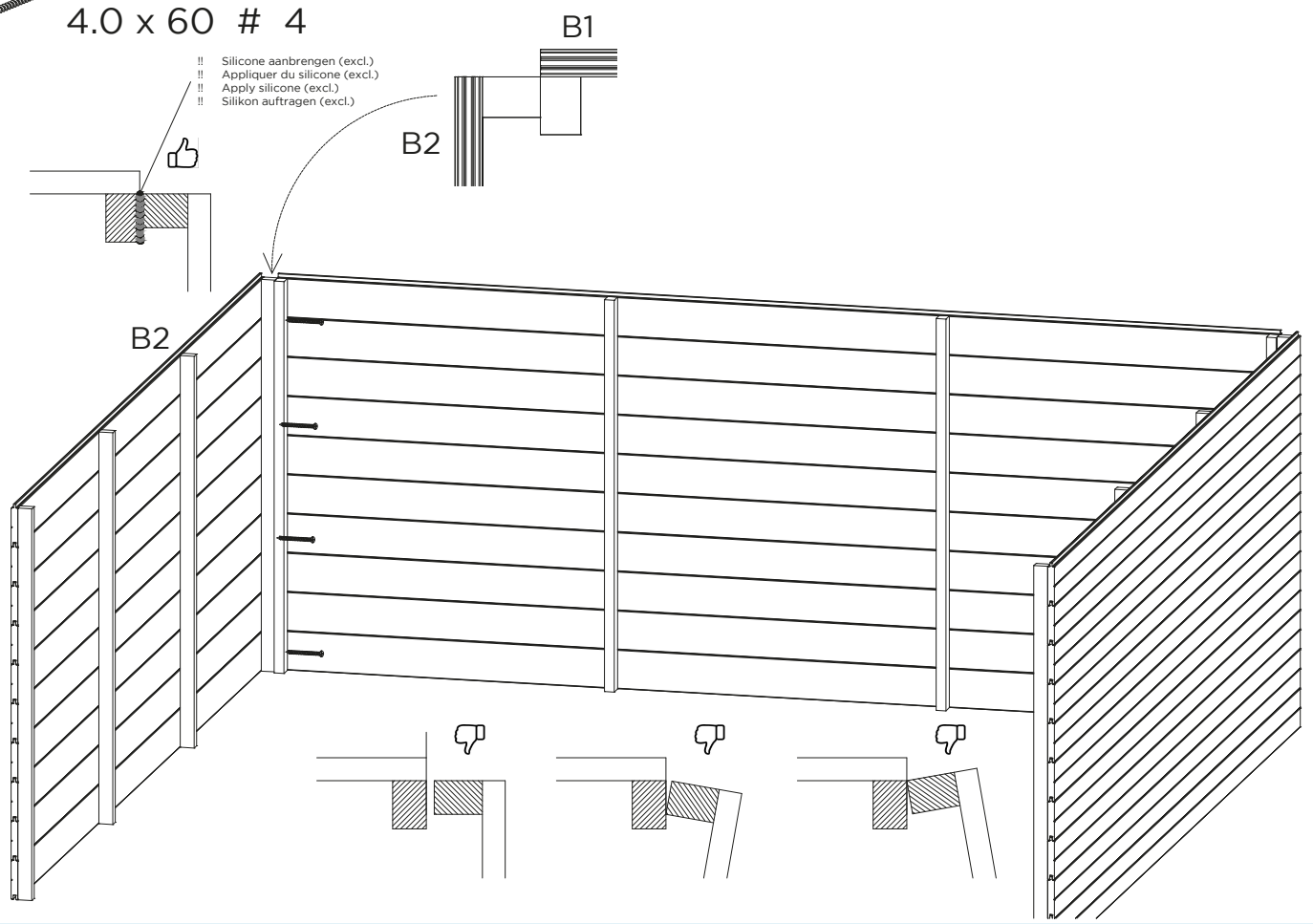

S8740-1

C = 2
 4.0 x 60 # 8

3

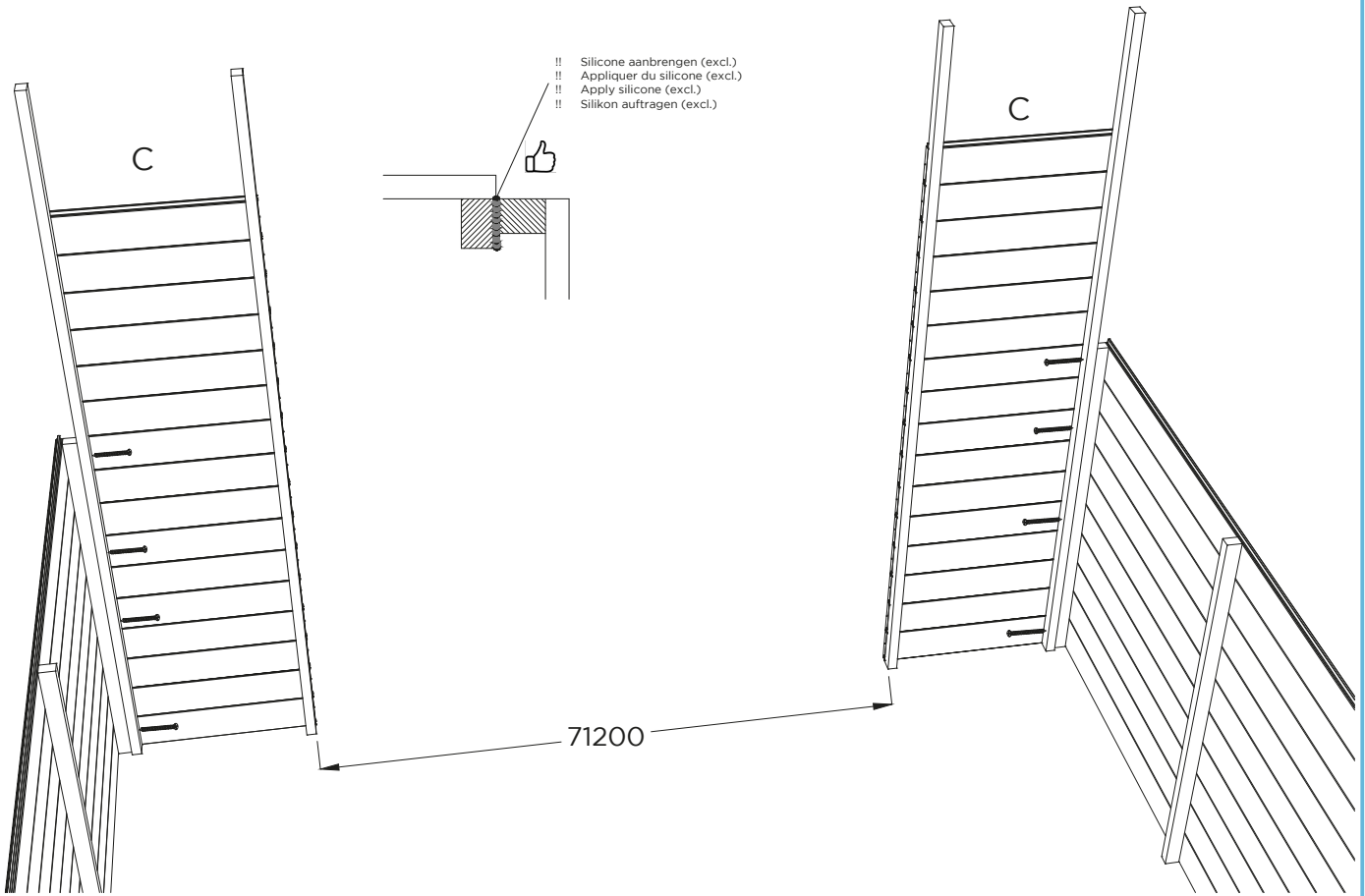

A2 = 1
A3 = 1
A4 = 1
 4.0 x 60 # 16

4

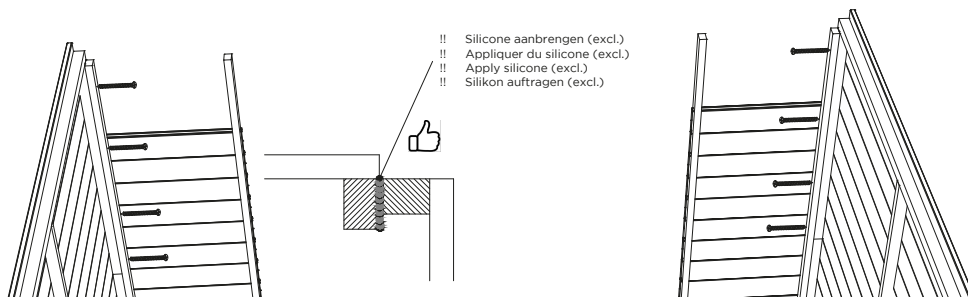
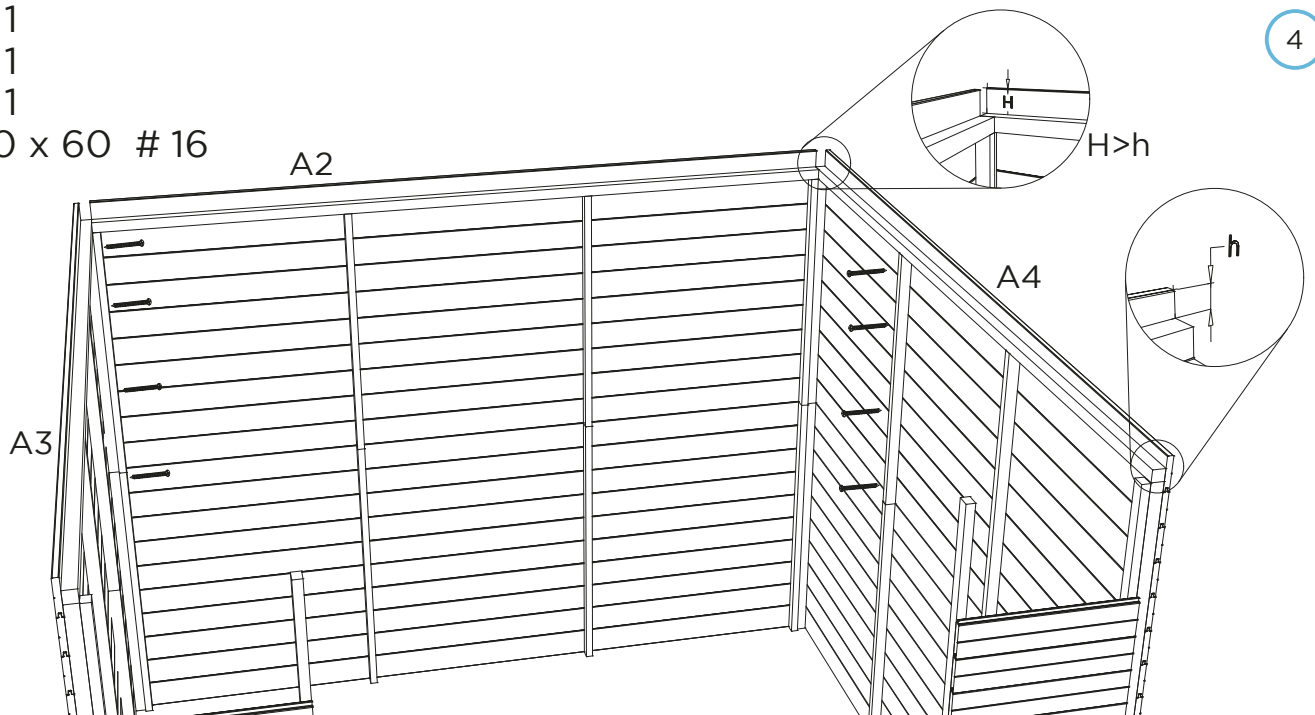

S8740-1

A1 = 1
4.0 x 60 # 10

5

- !! Silicone aanbrengen (excl.)
- !! Appliquer du silicone (excl.)
- !! Apply silicone (excl.)
- !! Silikon auftragen (excl.)

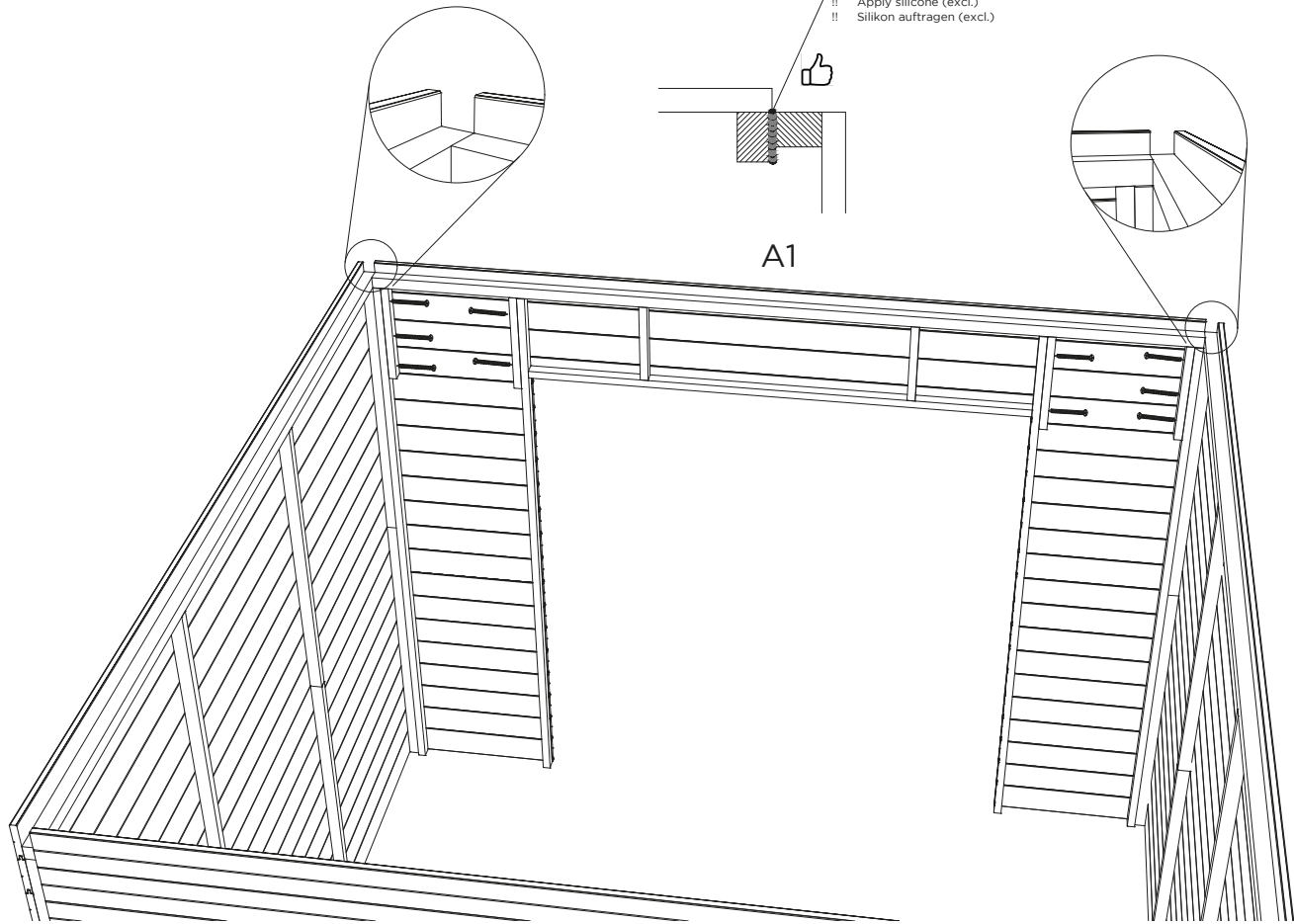



K = 2
4.0 x 60 # 4

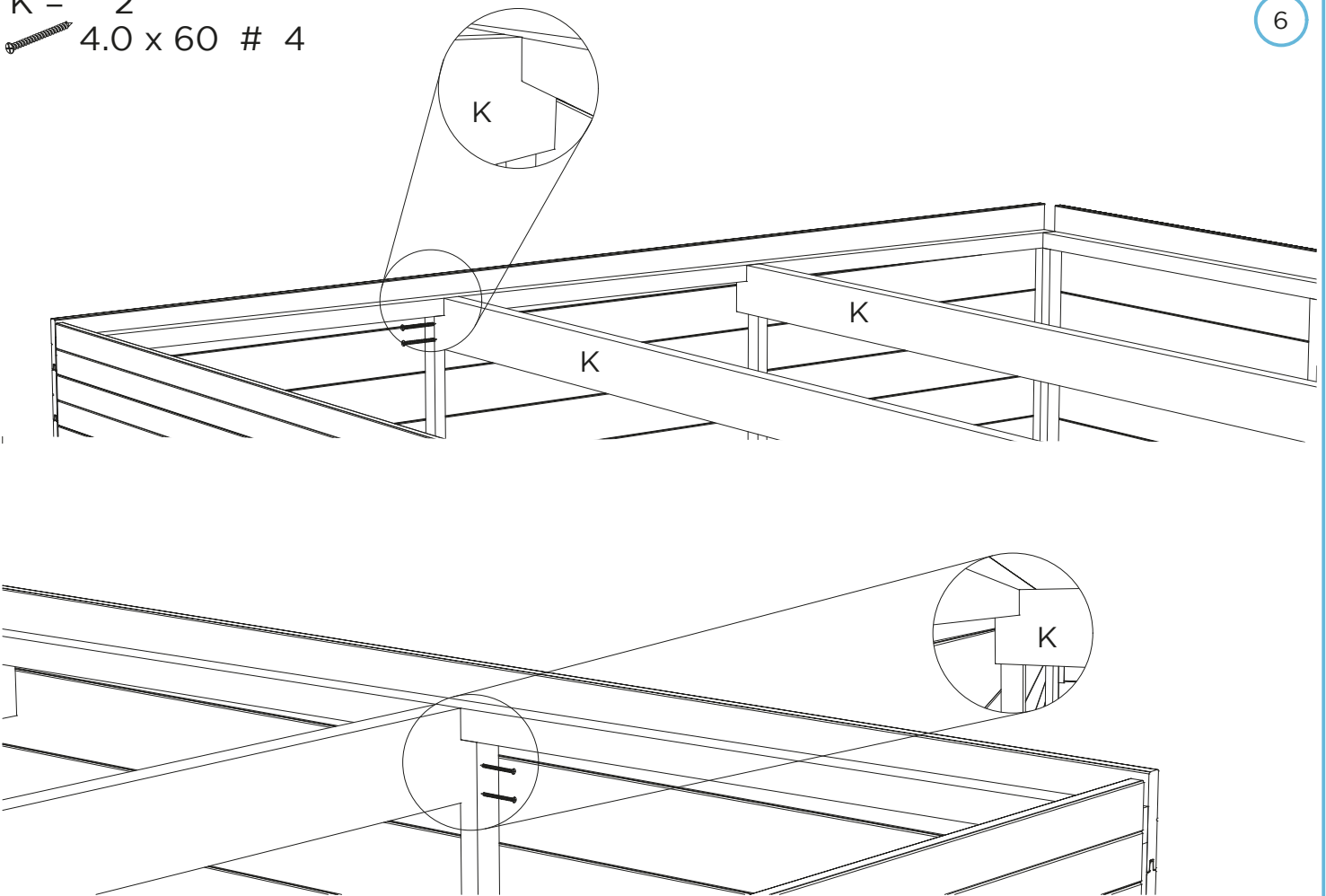

6

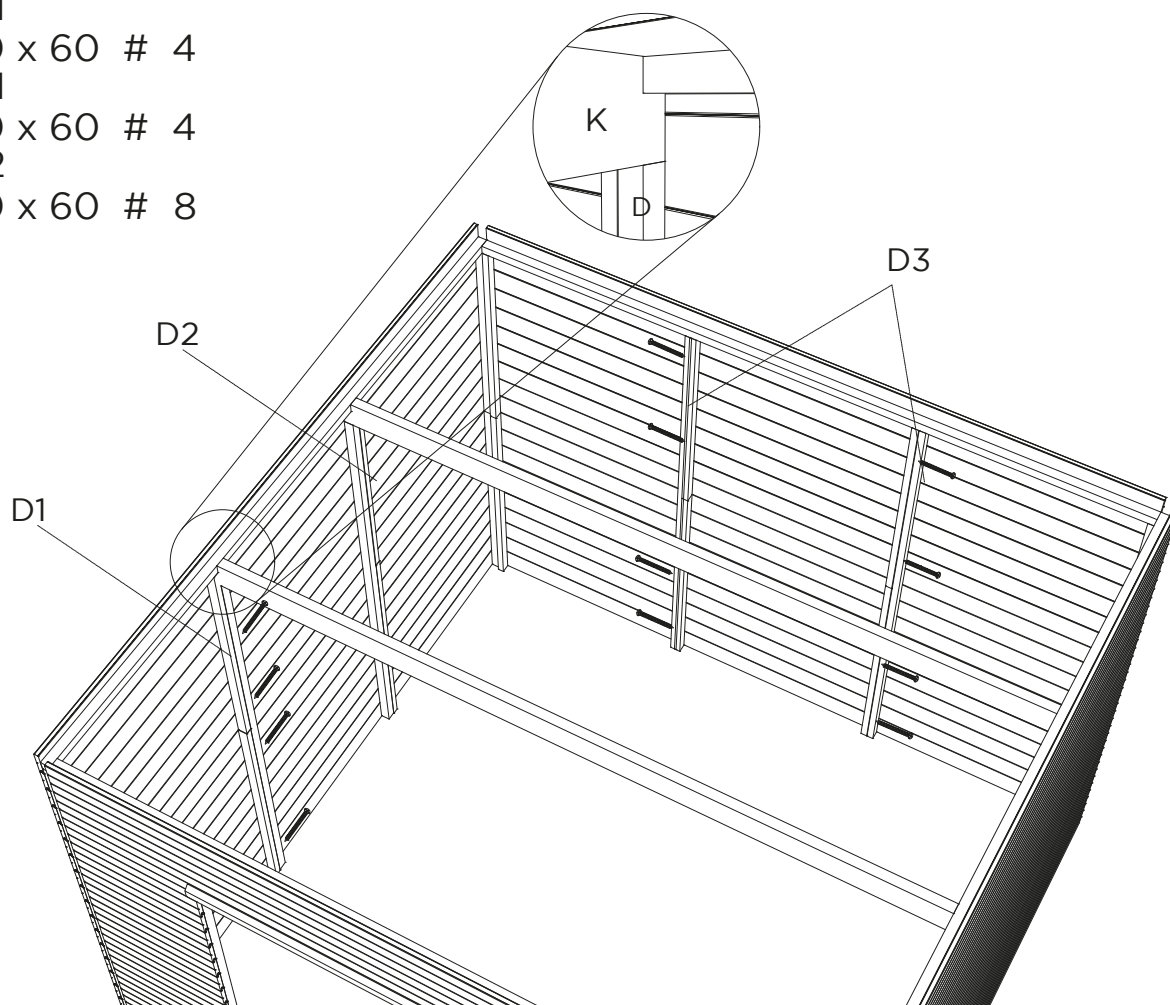

S8740-1

- D1 = 1
 4.0 x 60 # 4
- D2 = 1
 4.0 x 60 # 4
- D3 = 2
 4.0 x 60 # 8



- D1 = 1
 4.0 x 60 # 4
- D2 = 1
 4.0 x 60 # 4

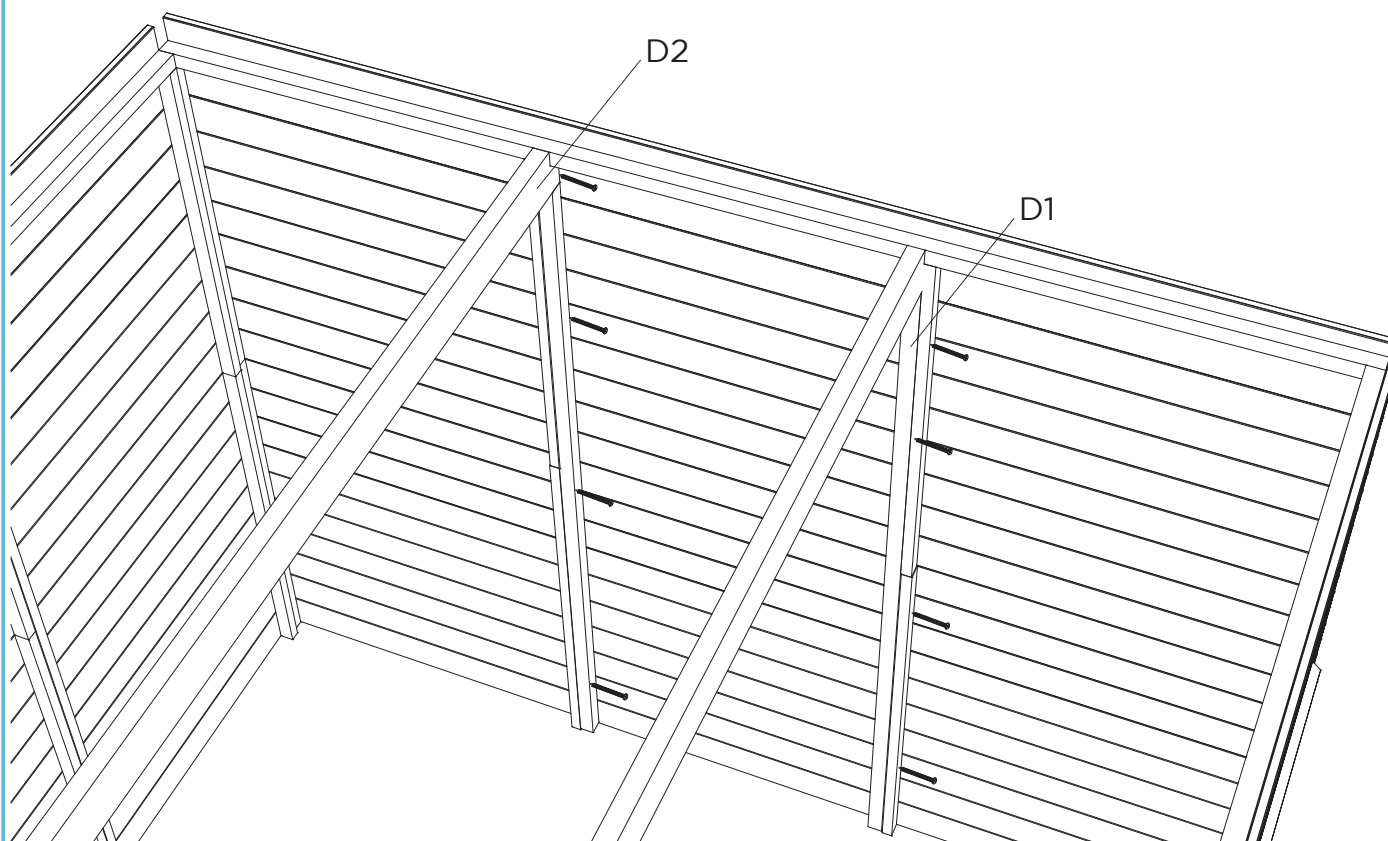

S8740-1

J = 34
2.5 x 40 # 180

8



min. 2 mm !!

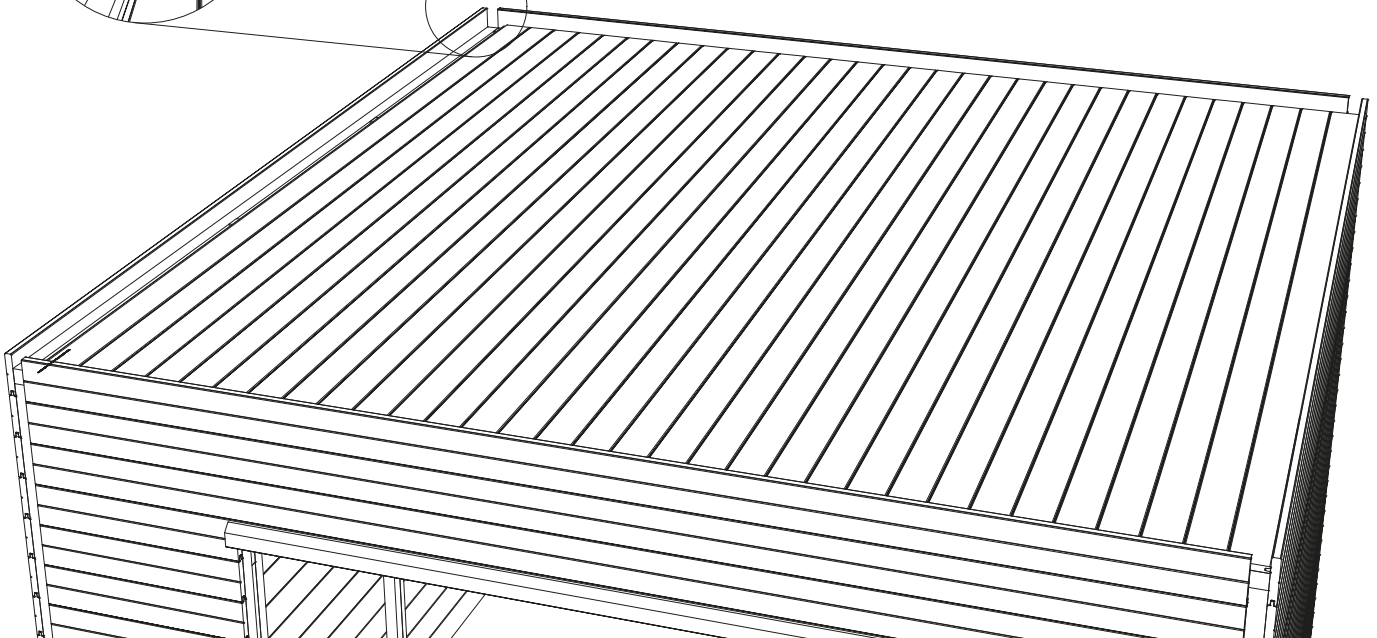
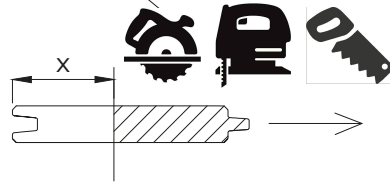
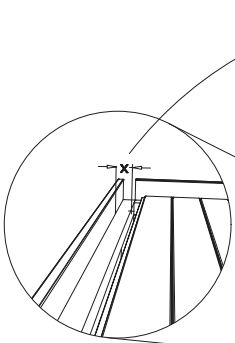
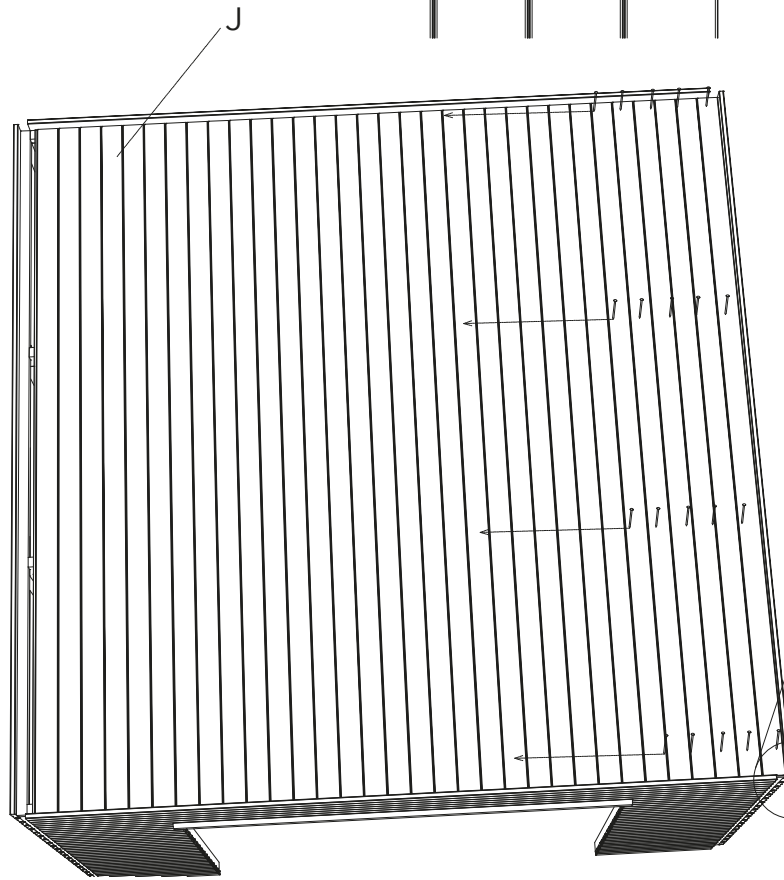

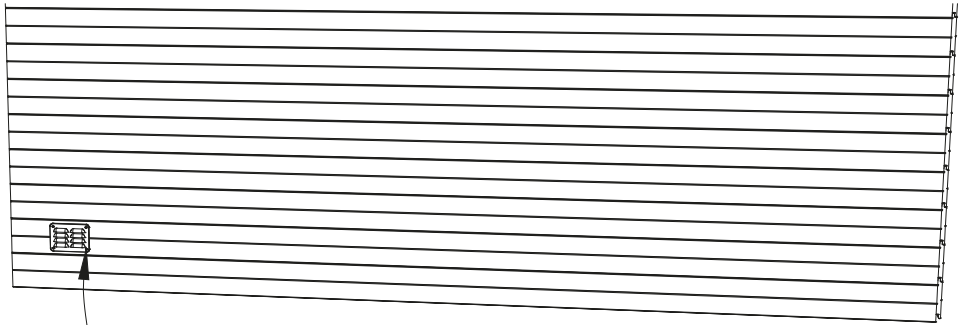
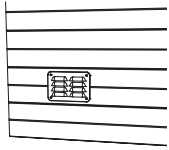

S6746 Ventilation-kit

S8741-1 BARI

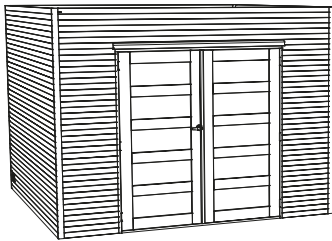

S8740-1
L = 4
3.0 x 40 # 16

Ga verder met de handleiding van **S8740-1**.

Continuer avec le manuel de **S8740-1**.

Continue with the manual from **S8740-1**.

Fahren Sie mit dem Handbuch von fort **S8740-1**.

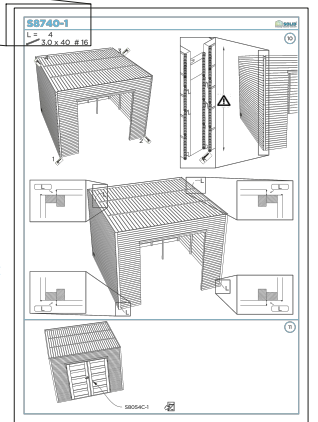

S8742-1 TARENTO

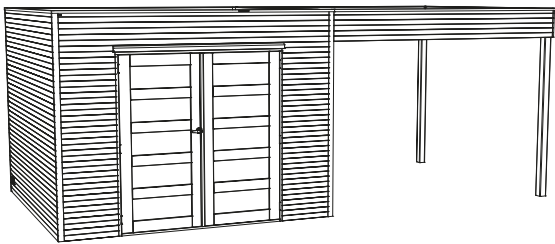

S8751-1
L = 4

Ga verder met de handleiding van **S8751-1**.

Continuer avec le manuel de **S8751-1**.

Continue with the manual from **S8751-1**.

Fahren Sie mit dem Handbuch von fort **S8751-1**.

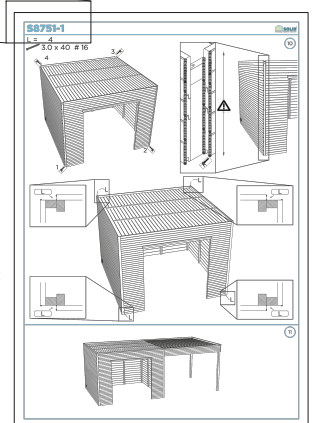

S8743-1 MATERA

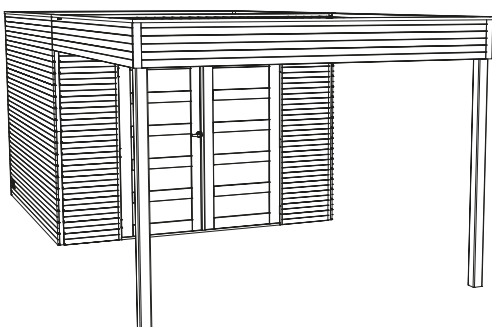

S8730-1 / S8740-1
L = 4

Ga verder met de handleiding van **S8752-1**.

Continuer avec le manuel de **S8752-1**.

Continue with the manual from **S8752-1**.

Fahren Sie mit dem Handbuch von fort **S8752-1**.

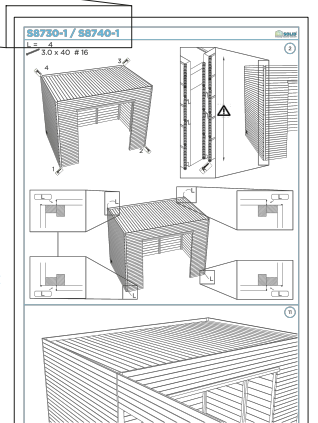

S8751-1

L = 4
3.0 x 40 # 16

10

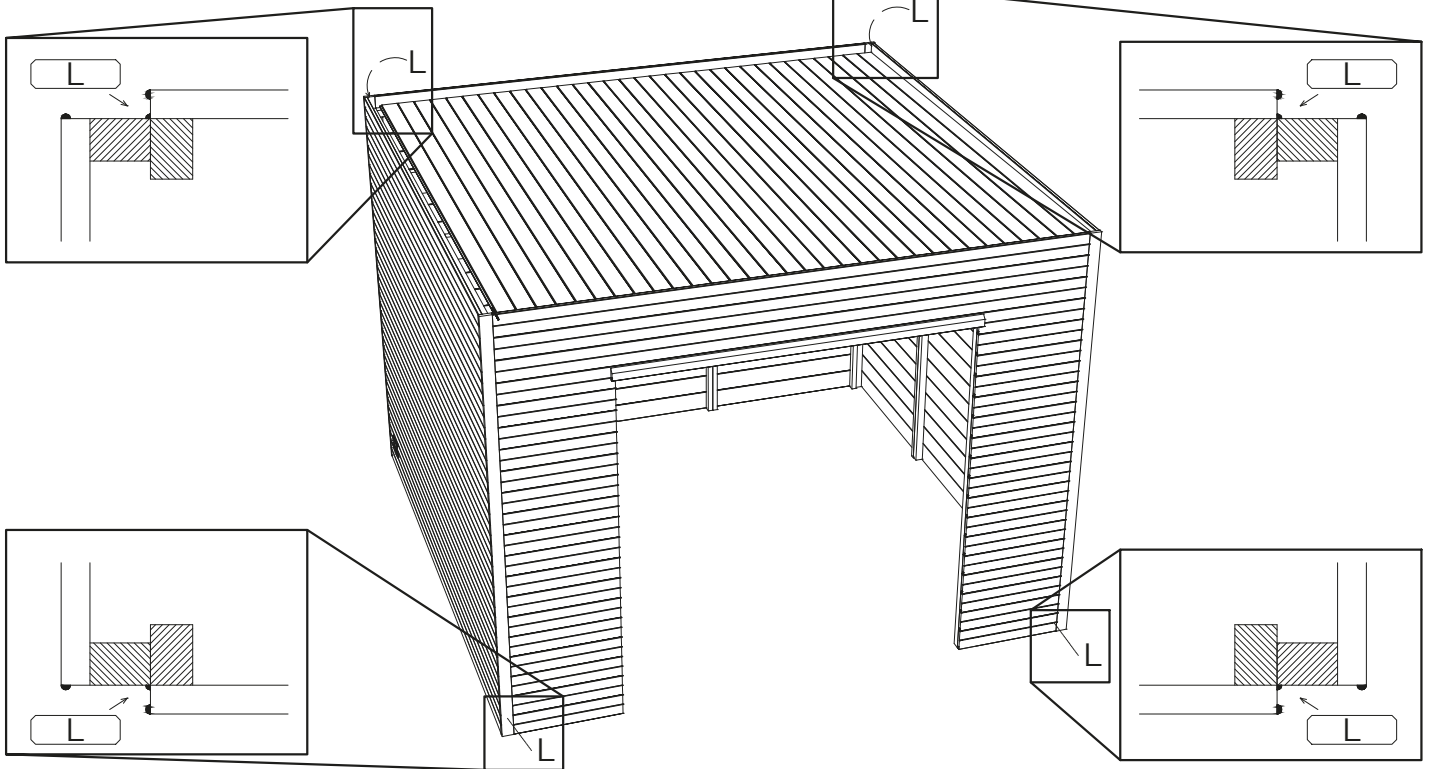
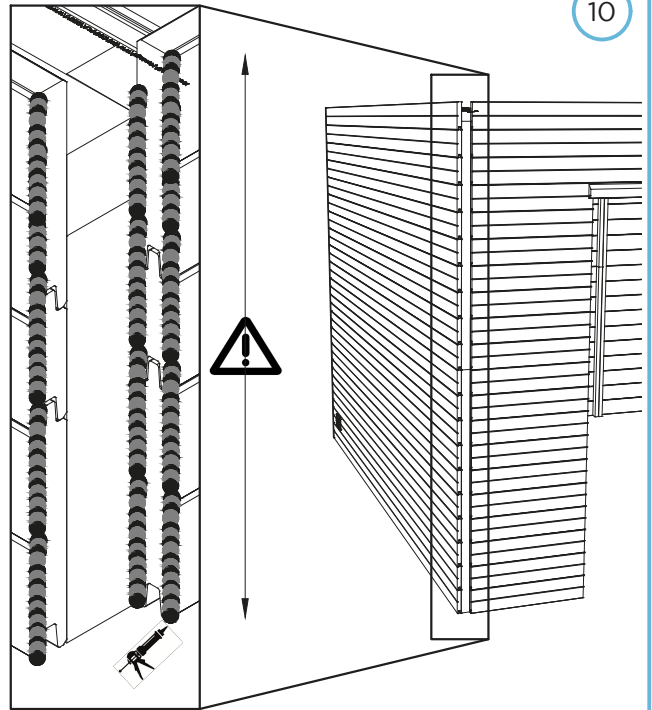
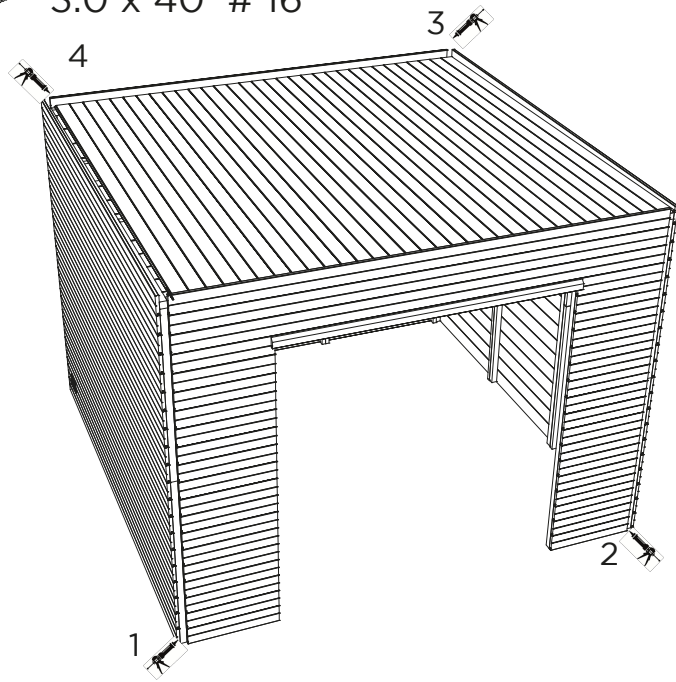

11

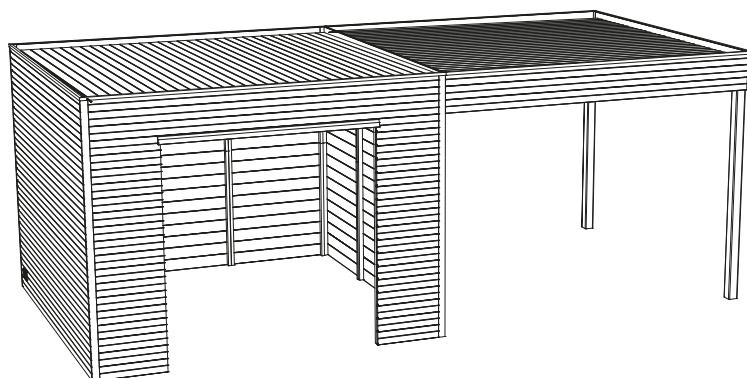

S8751-1

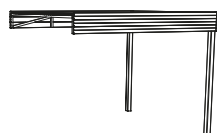

ASKAO



Afmetingen, uiterlijk, vorm, gewicht kunnen afwijken.
Les dimensions, l'apparence, la forme, le poids peuvent différer.
Dimensions, appearance, shape, weight may differ.
Maße, Aussehen, Form, Gewicht können abweichen.

www.solid.eu/sav

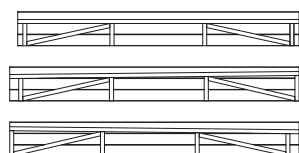

Ref.	Index	#
A1	WP019x123-CDER-TER-1-0336x2790	1
A2	WP019x123-CGAU-TER-1-0336x2870	1
A3	WP019x123-CDRO-TER-1-0336x2870	1
D1	WW040x095-4FA-Y45-1-0455	2
D2	WW040x040-4FA-000-1-2790	1
D3	WW040x040-4FA-000-1-0130	1
J	WW016x095-PLA-000-1-2867	33
K	WW040x145-4FA-IF0-1-2870	2
L	WW019x059-4FA-000-1-0336	2
O	S5015 EPDM (3200x3200)	1
O1	S5010 Contactspray	4
S	RW088x088-4R8-000-1-2124	2
R	S8751-Zmt	1
	<ul style="list-style-type: none"> 2.5 x 40 #132 3.0 x 40 #8 4.0 x 60 #38 5.0 x 90 #2 	
V1	S5018 Drainage pipe connection	1
V2	S5232 Drainage pipe	1
V3	S5238 Drainage pipe corner 45°	2
V4	S5236 Fixo PVC	2
X1	S6705 25x25x3 LINKS (2896)	1
X2	S6706 25x25x3 RECHTS (2896)	1
X3	S6707 25x25x3 CENTER (2916)	1

Gereedschap (excl.) / Outils (excl.) / Tools (excl.) / Werkzeuge (exkl.)



Hamer
Marteau
Hammer
Hammer



Schroefboormachine
Perceuse / Visseuse
Screw drill
Schraubenbohrer



Ladder
Echelle
Ladder
Leiter



Winkelhaak
Crochet carré
Square hook
Quadratischer Haken



Cirkelzaag
Scie circulaire
Circular saw
Kreissäge



Klokboor Ø 60mm
Scie cloche Ø 60mm
Hole saw Ø 60mm
Bohren Ø 60mm



Handzaag
Scie à main
Saw
Säge



Meter
Mètre
Meter
Rollenmesser



Breekmes
Couteau
Cutter
Messer



Waterpas
Niveau à bulle
Plumb rule
Wasserwaage



Decoupeerzaag
Scie sauteuse
Jigsaw
Stichsäge



Silicone + pomp
Silicone + pompe
Silicone + pump
Silikon + Pumpe

S8740-1

A1 = 1
S = 2
 4.0 x 60 # 4

1

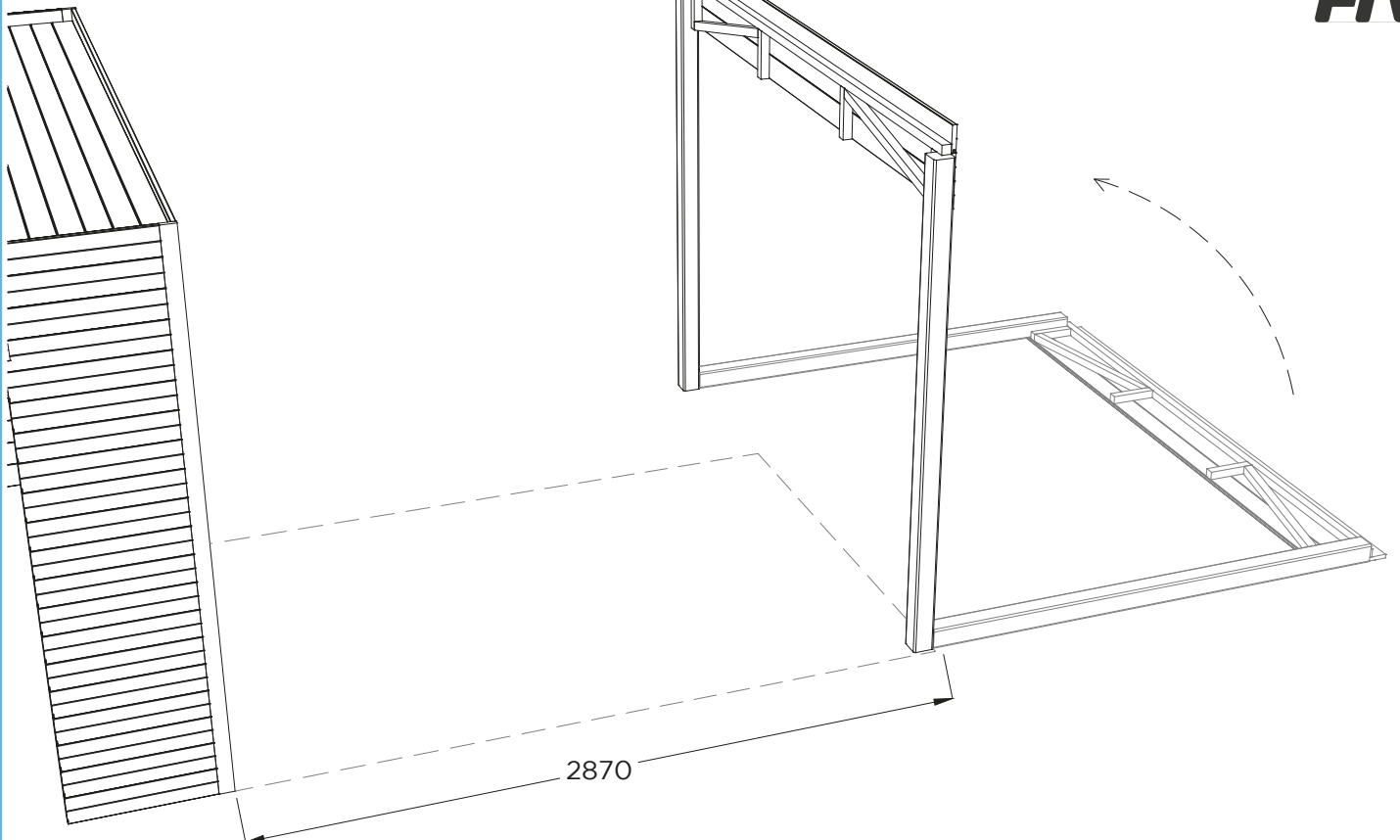
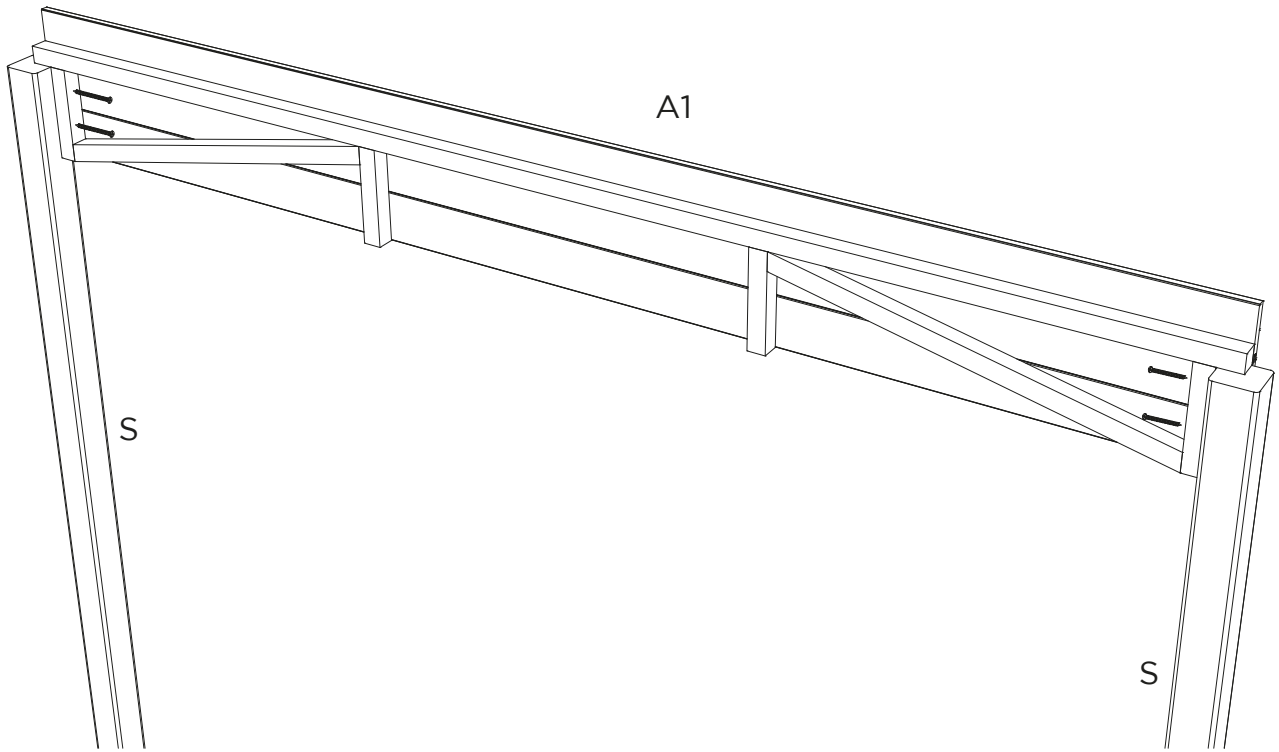

S8740-1

A2 = 1
 4.0 x 60 # 4

2

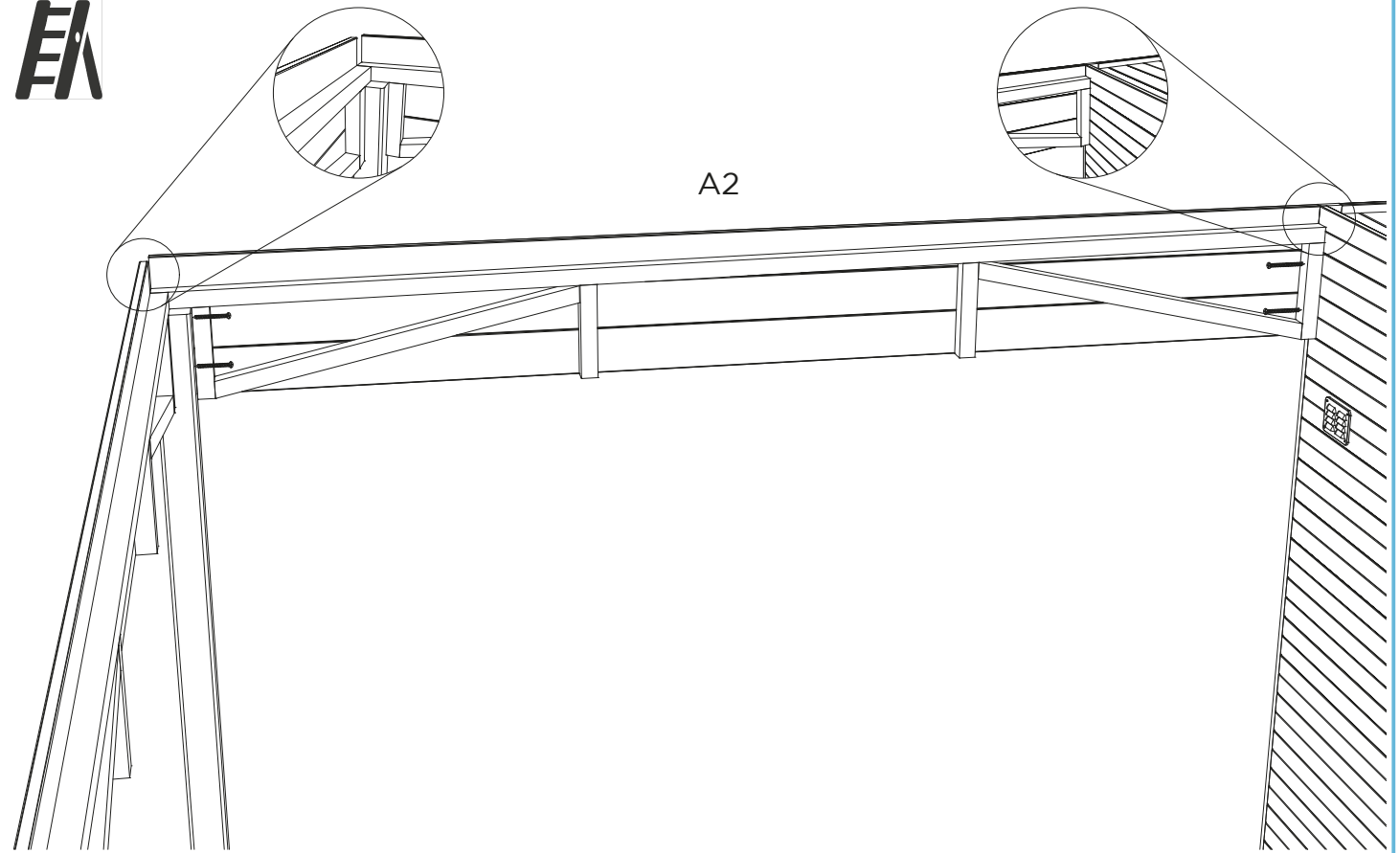

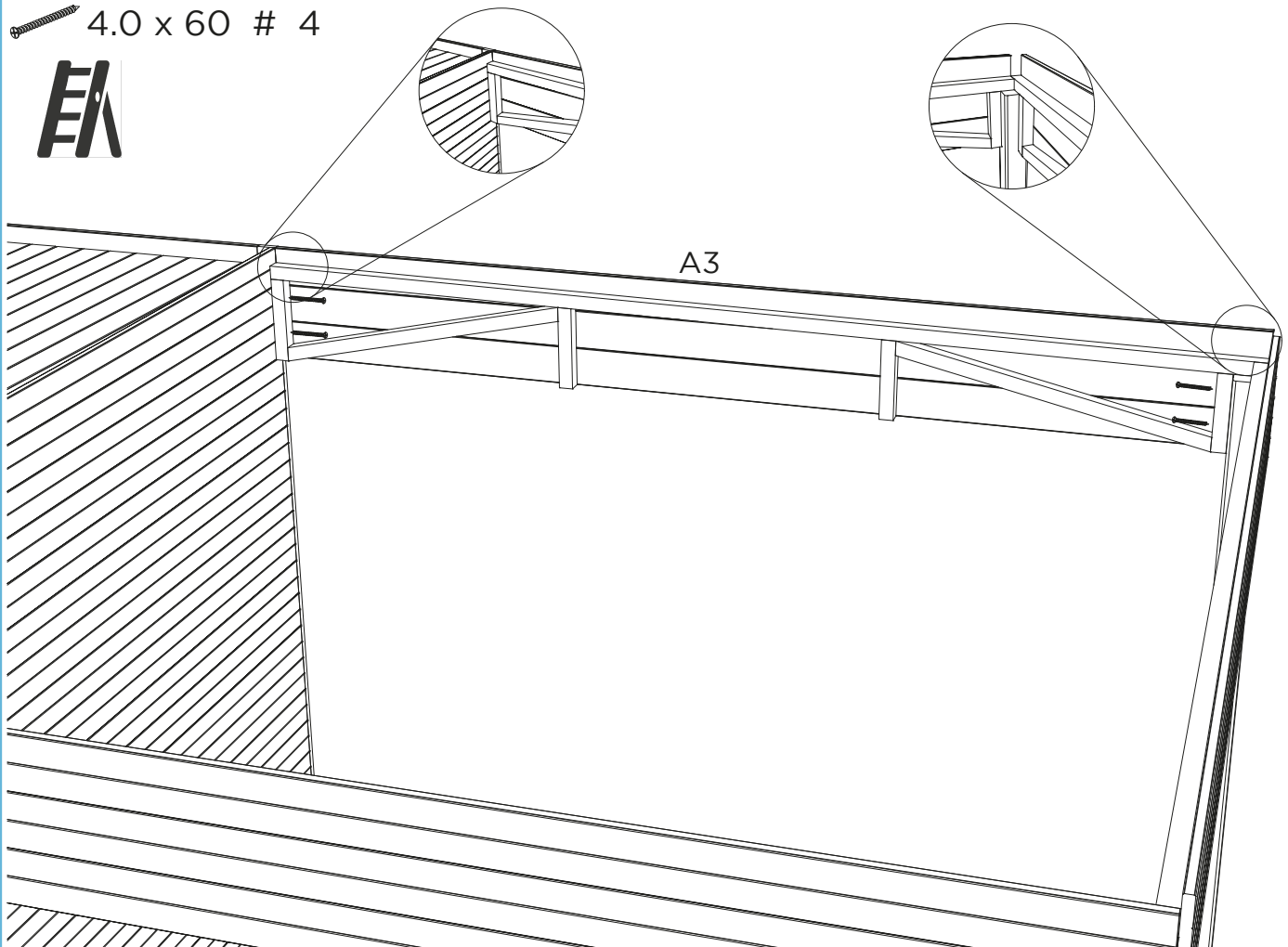

A3 = 1
 4.0 x 60 # 4



S8740-1

3

- D2 = 1
-  4.0 x 60 # 2
-  5.0 x 90 # 2
- L = 2
-  3.0 x 40 # 8

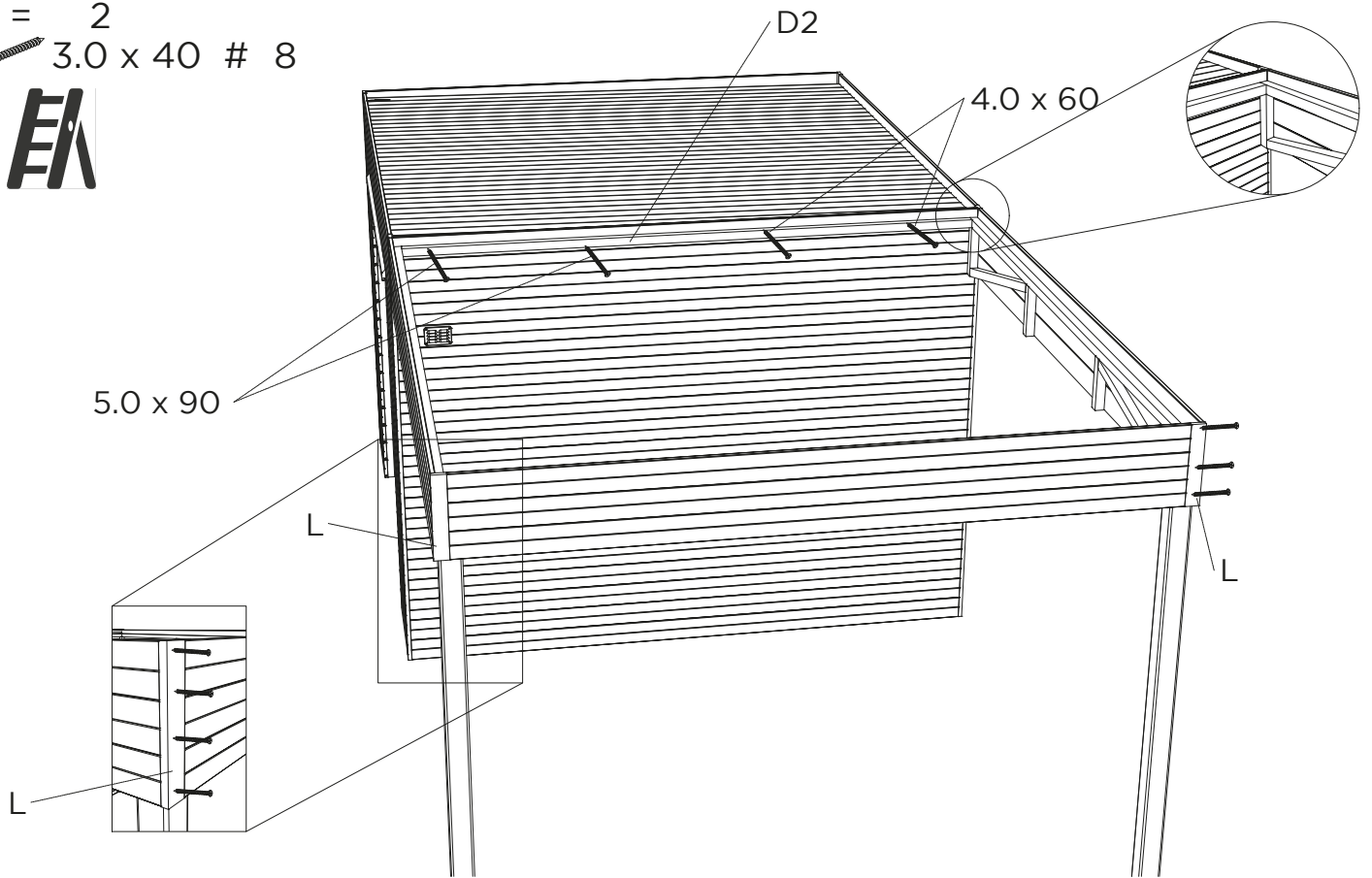

- D1 = 2
- D3 = 4
- K = 2
-  4.0 x 60 #24

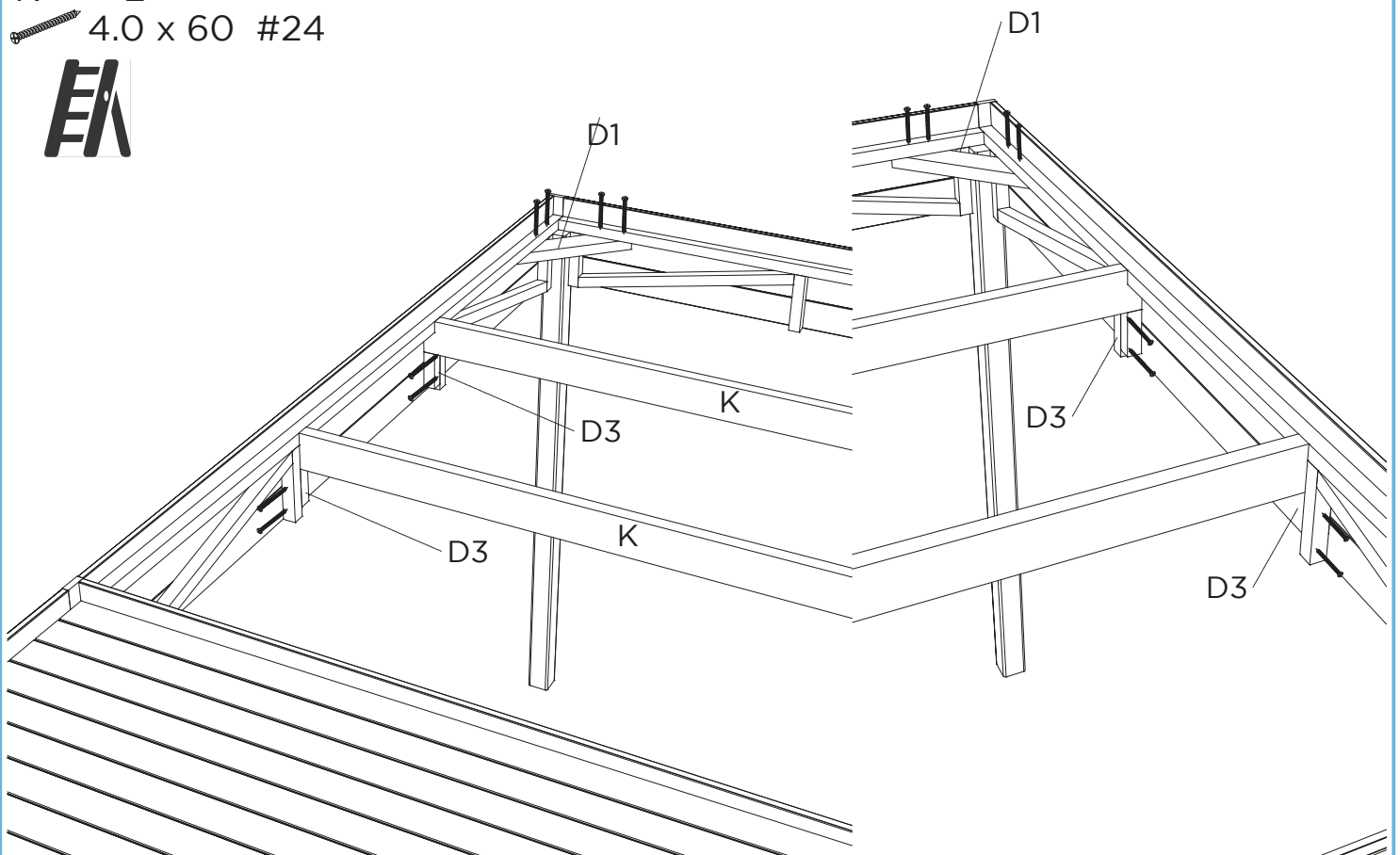

4

S8740-1

J = 23
2.5 x 40 # 136

5

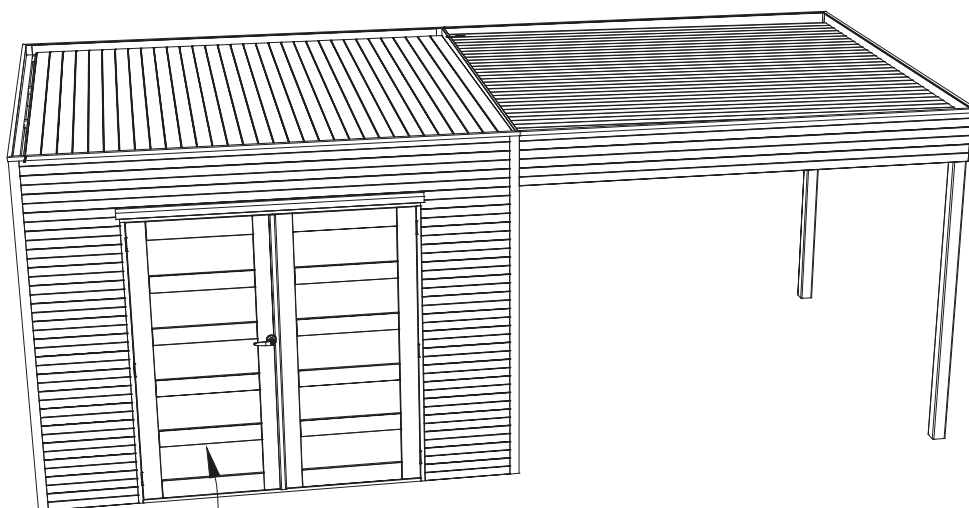
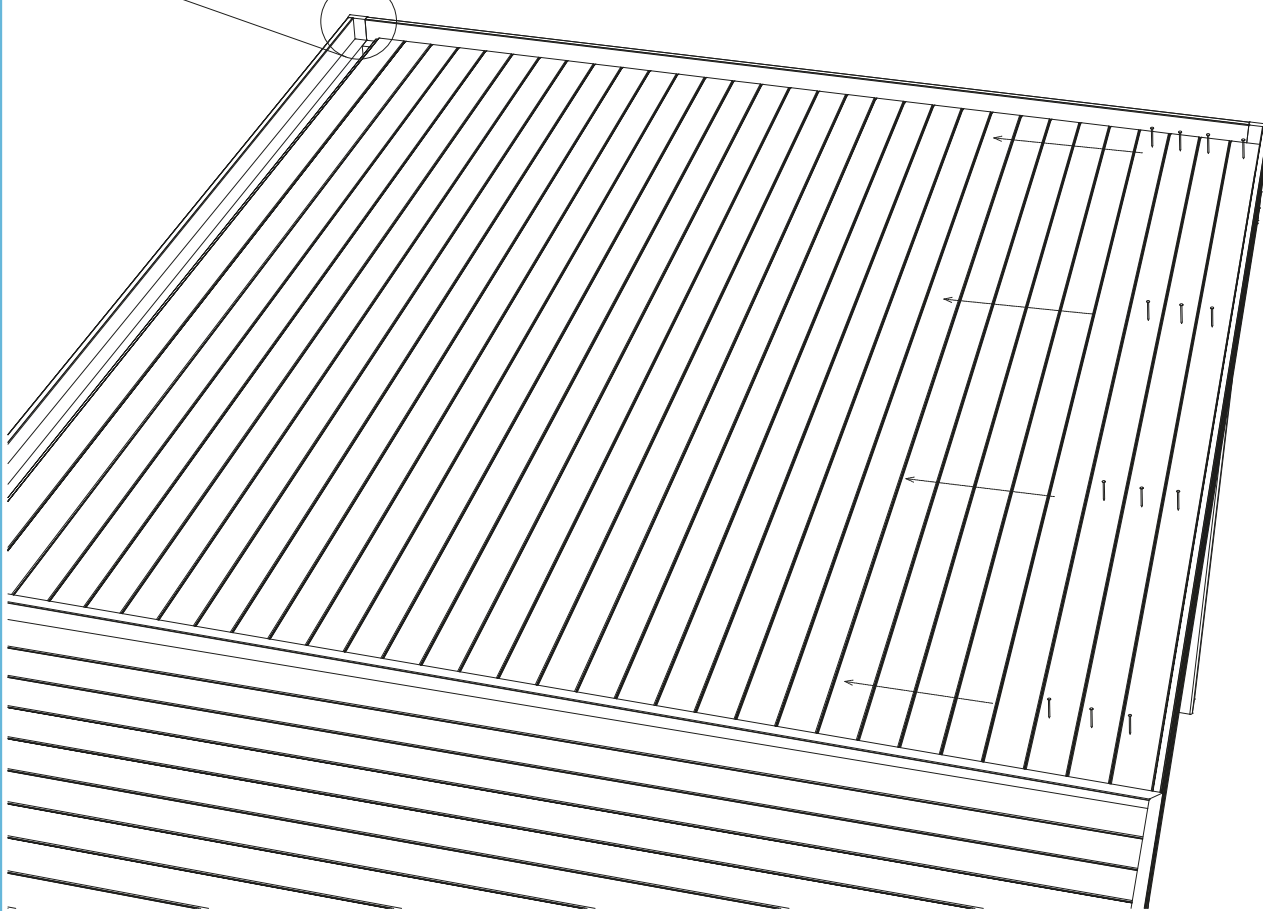
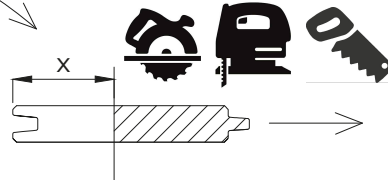
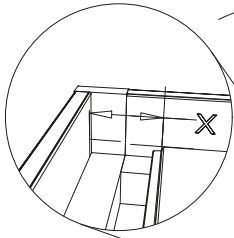
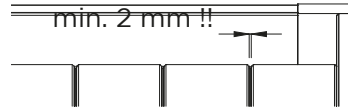

6

S8054C-1



EPDM (CONTACTSPRAY)

1

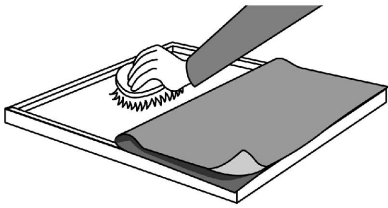

2

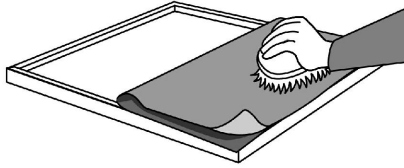

3

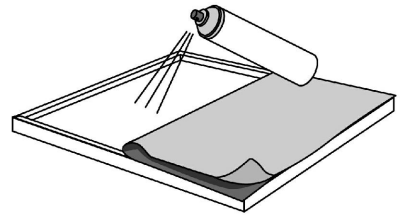

4

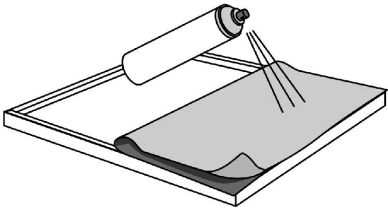

5

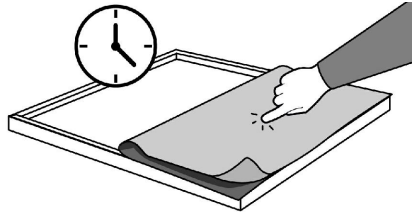

6

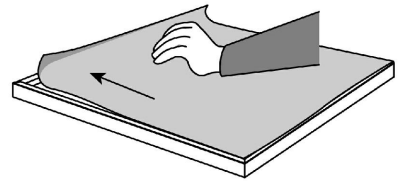

7

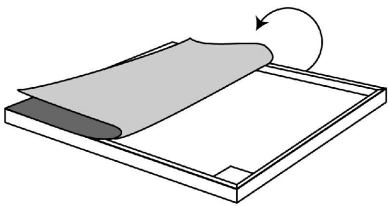

8

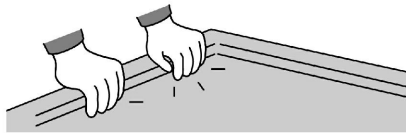

9



10



11

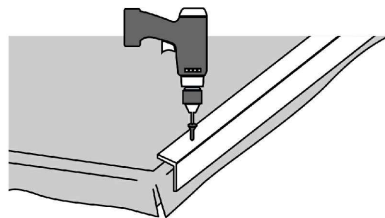

12

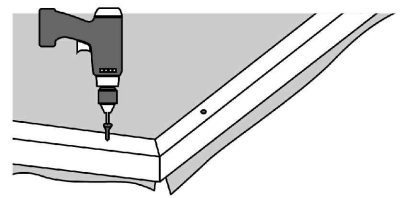

13

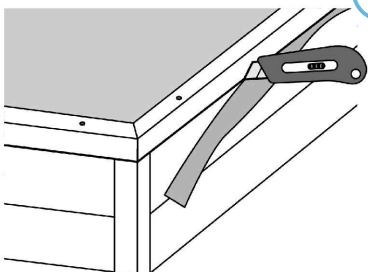

14

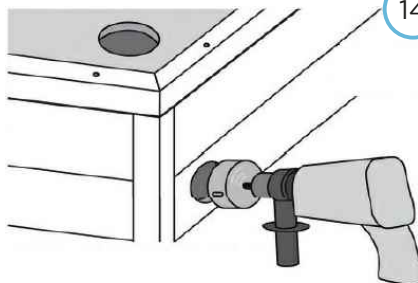

15

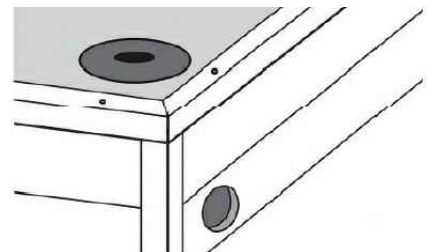

16

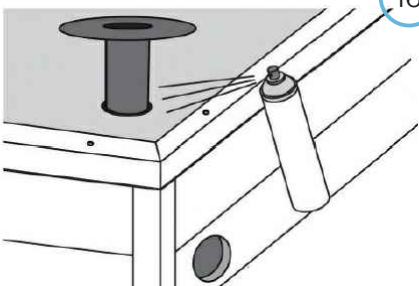

17

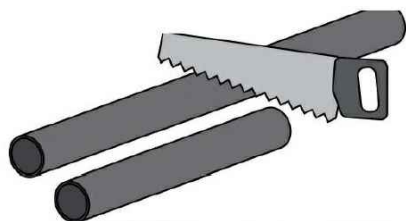

18

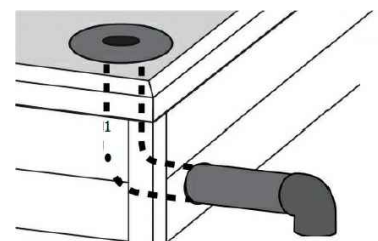

S8054-1

Ref.

Index

#

ok/nok



ASKAO

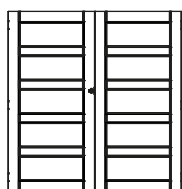
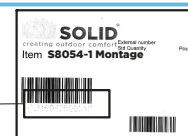

↓	↓	↓
P	S8054-1	1

Stuklijst / Liste des pièces / Bill of material / Materialliste



S8730-1

	Ref.	Index	#	# nok
	P	S8054-K-1	1	
		S8084-ALU	1	
		S618	1	
		4.0 x 70 #2 Ø4.0 #2		
		S80201	1	
		S6203-L	3	
		S6203-R	3	
		S673 (x2)	1	



Tip / Conseil / Advice / Beratung

Het kan gebeuren dat er vlekjes op het glas zichtbaar zijn. Dit is het gevolg van de impregnatie. Deze kunnen verwijderd worden met warm water en een niet-schurende spons. Een wonderspons kan ook gebruikt worden ofwel met ijzerwol '000'.

Il peut arriver que des taches soient visibles sur le verre. C'est le résultat de l'imprégnation. Ceux-ci peuvent être enlevés avec de l'eau tiède et une éponge non abrasive. Une éponge miracle peut également être utilisée, ou avec de la laine de fer '000'.

It may happen that spots are visible on the glass. This is the result of the impregnation. These spots can be removed with warm water and a non-abrasive sponge. A miracle sponge can also be used, or iron wool '000'.

Es kann vorkommen, dass Flecken auf dem Glas sichtbar sind. Dies ist das Ergebnis der Imprägnierung. Diese können mit warmem Wasser und einem nicht scheuernden Schwamm entfernt werden. Ein Wunderschwamm kann auch mit Eisenwolle '000' verwendet werden.



Gereedschap (excl.) / Outils (excl.) / Tools (excl.) / Werkzeuge (exkl.)



Hamer
Marteau
Hammer
Hammer



Schroefboormachine
Perceuse / Visseuse
Screw drill
Schraubenbohrer



Ladder
Echelle
Ladder
Leiter



Winkelhaak
Crochet carré
Square hook
Quadratischer Haken



Cirkelzaag
Scie circulaire
Circular saw
Kreissäge



Klokboor Ø 60mm
Scie cloche Ø 60mm
Hole saw Ø 60mm
Bohren Ø 60mm



Handzaag
Scie à main
Saw
Säge



Meter
Mètre
Meter
Rollenmesser

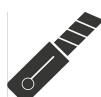

Breekmas
Couteau
Cutter
Messer



Waterpas
Niveau à bulle
Plumb rule
Wasserwaage



Decoupeerzaag
Scie sauteuse
Jigsaw
Stichsäge



Silicone + pomp
Silicone + pompe
Silicone + pump
Silikon + Pumpe

S8054-1

4.0 x 50 # 2

1

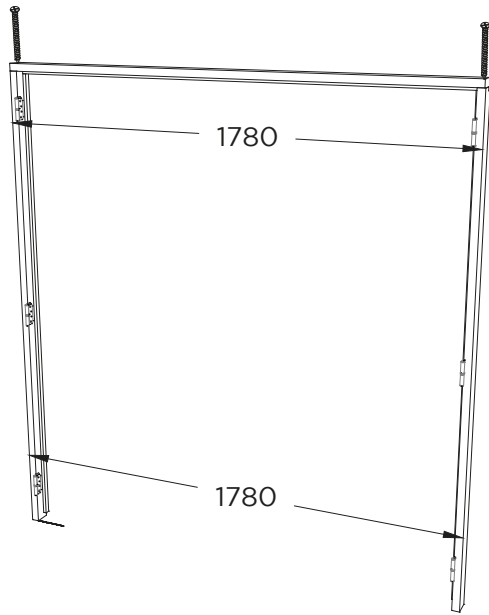

2

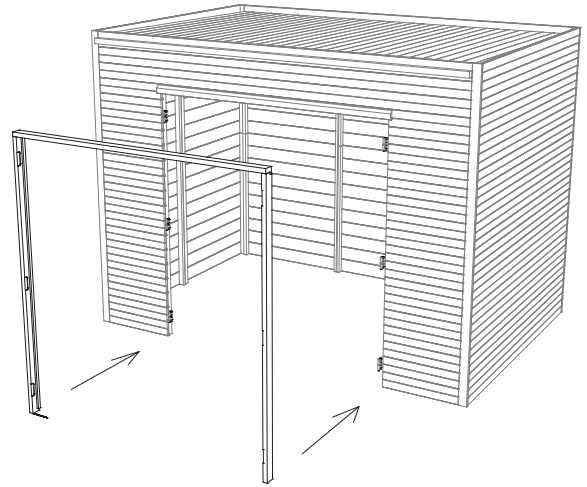

4.0 x 50 # 11

3

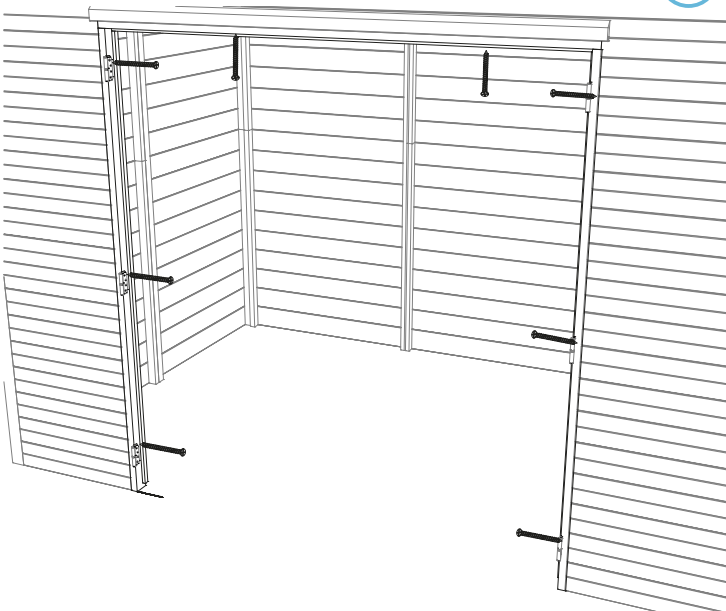

4

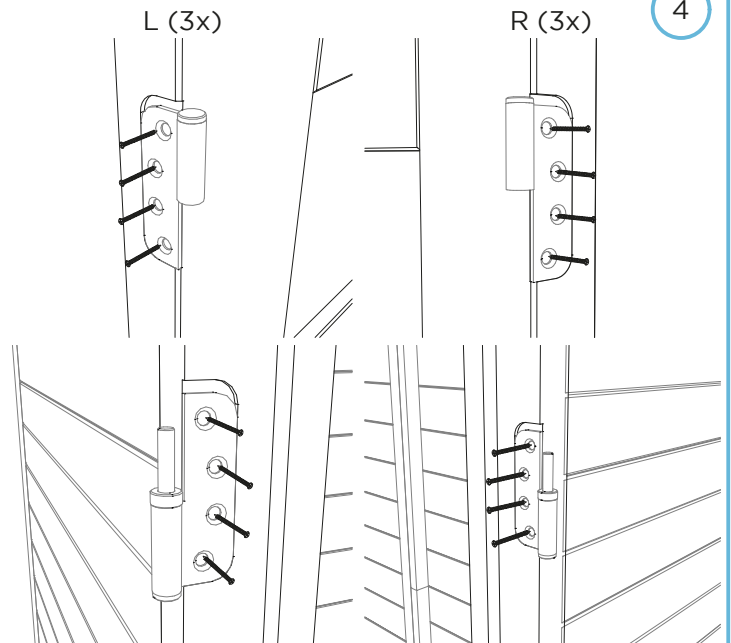

5

4.0 x 30 # 4

6

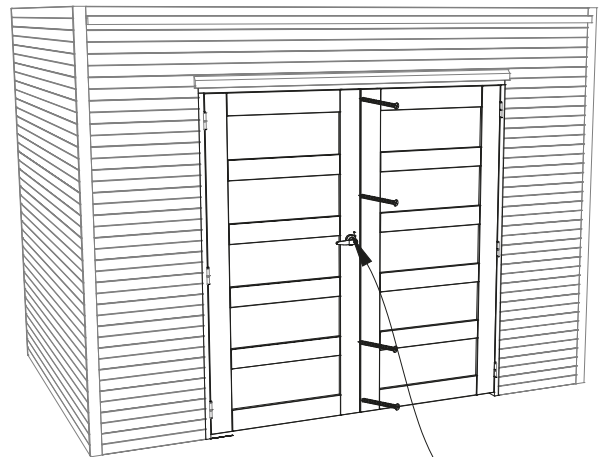
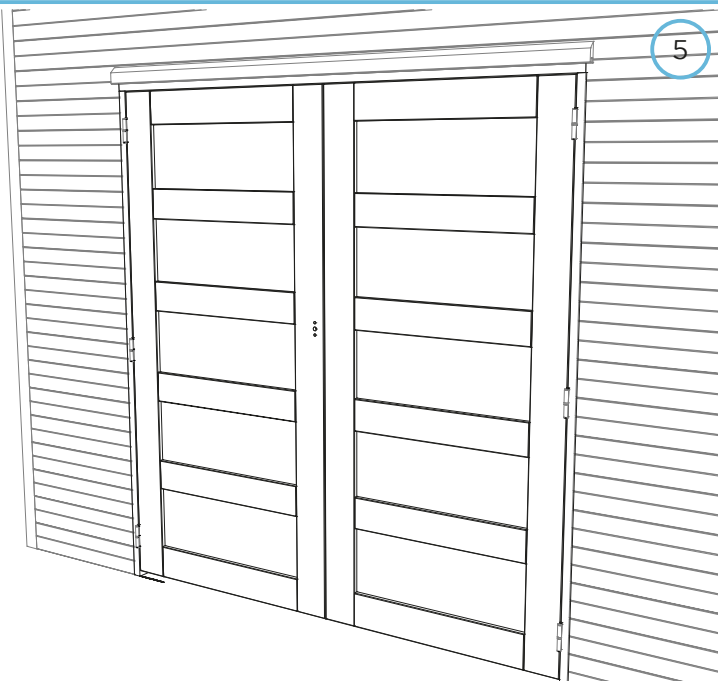

S80201